

IMLCCSOFABOUCL / IMLCCSOFABCLUK

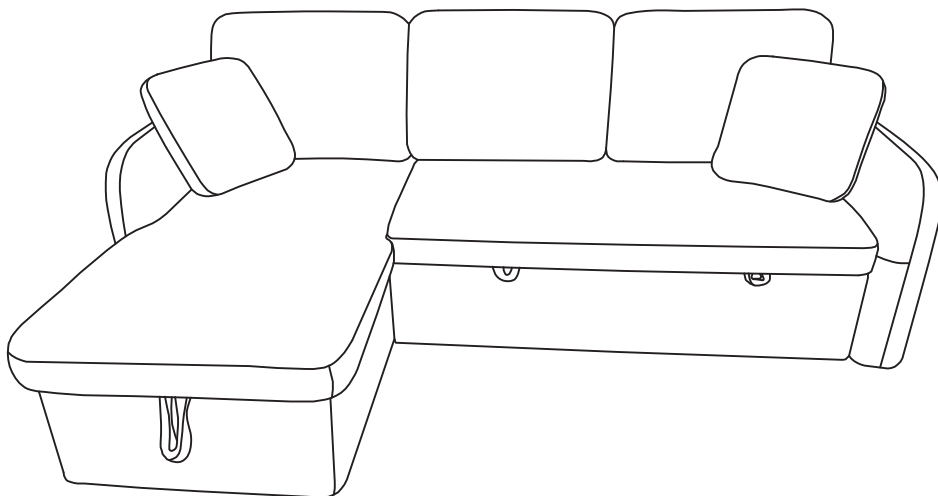

sweeek.fr - sweeek.be - sweeek.es - sweeek.nl - sweeek.co.uk
sweeek.pt - sweeek.it - sweeek.de - sweeek.pl

FRANÇAIS

Conseils d'entretien.....	6
Conseils d'utilisation.....	7
Garantie.....	8
Montage.....	9

**IMPORTANT, À CONSERVER
POUR CONSULTATION ULTÉRIEURE :
À LIRE ATTENTIVEMENT**

ESPAÑOL

Consejos de mantenimiento.....	6
Consejos de uso.....	7
Garantía.....	8
Montaje.....	9

**IMPORTANTE, CONSERVAR PARA FU-
TURAS CONSULTAS: LEER ATENTA-
MENTE**

ENGLISH

Directions for maintenance.....	6
Directions for use.....	7
Warranty.....	8
Assembly.....	9

**IMPORTANT, RETAIN FOR FUTURE
REFERENCE: PLEASE READ
CAREFULLY**

NEDERLANDS

Onderhoud.....	6
Gebruiksadviezen.....	7
Garantie.....	8
Montage.....	9

**BELANGRIJK, BEWAAR VOOR
TOEKOMSTIGE REFERENTIE:
ZORGVULDIG LEZEN**

PORTUGUÊS

Dicas para cuidar.....	6
Dicas para usar	7
Garantia.....	8
Montagem.....	9

**IMPORTANTE, PARA CONSEGUIR FU-
TURO REFERÊNCIA: PARA LER COM
ATENÇÃO**

ITALIANO

Consigli per la manutenzione	6
Consigli d'uso	7
Garanzia.....	8
Montaggio.....	9

**IMPORTANTE, CONSERVARE
PER ULTERIORI CONSULTAZIONI:
LEGGERE ATTENTAMENTE**

DEUTSCH

Pflegehinweise	6
Verwendungshinweise.....	7
Garantie.....	8
Montage	9

**WICHTIG, FÜR SPÄTEREN
GEBRAUCH AUFBEWAHREN:
BITTE SORGFÄLTIG LESEN**



Destiné à un usage domestique
Destinado a un uso doméstico
For domestic use
Bestemd voor huishoudelijk gebruik
Para uso doméstico
Destinato ad un uso domestico
Nur für den Privatgebrauch vorgesehen



Poids d'assise maximal : 110kg
Peso máximo del asiento: 110 kg
Maximum seat weight: 110kg
Maximale zitplaatsen gewicht 110kg
Peso máximo do assento: 110 kg
Peso massimo del sedile: 110kg
Maximale Belastbarkeit: 110kg



Garantie : 2 ans
Garantía : 2 años
Warranty: 2 years
Garantie: 2 jaar
Garantia: 2 anos
Garanzia : 2 anni
Garantie: 2 Jahre

CONSEILS D'ENTRETIEN / CONSEJOS DE MANTENIMIENTO / DIRECTIONS FOR MAINTENANCE / ONDERHOUD / DICAS PARA CUIDAR / CONSIGLI PER LA MANUTENZIONE / PFLEGEHINWEISE

FR

Si vous ouvrez le carton, puis trouvez des rayures sur le canapé ou les accoudoirs, veuillez utiliser une serviette pour l'essuyer plusieurs minutes jusqu'à atténuation.

Proscrire tout abrasif et produits acides. Ne jamais employer de solvants. Nettoyage professionnel uniquement.

Bois : Dépoussiérer régulièrement avec un chiffon propre, doux et sec.

ES

Si durante la apertura de la caja de cartón encuentra arañazos en el sofá o los sillones, límpielo con una toalla durante unos minutos hasta que desaparezca.

Prohíba el uso de estropajos y productos ácidos. No utilice nunca disolventes de limpieza. Sólo se puede realizar una limpieza profesional.

Madera: Limpie regularmente el polvo con un plumero limpio, suave y seco.

EN

If during the opening of the carton box you find scratches on the sofa or armchairs, please wipe it with a cloth for a few minutes until it disappears.

Forbid any scourer and acidic products. Never use cleaning solvent. Professional cleaning only.

Wood: Regularly dust with a clean, soft and dry cloth.

NL

Als u de doos opent en krassen ziet op de sofa of de armleuningen, gebruik dan een handdoek en veeg het gedurende enkele minuten af tot het weer glad is.

Sluit alle schurende en zure producten uit. Gebruik nooit oplosmiddelen.

Alleen professionele reiniging.

Hout: Stof regelmatig af met een schone, zachte en droge doek. Alleen

PT

Se durante a abertura da caixa de cartão encontrar arranhões no sofá ou nas cadeiras de malas, limpe-a com uma toalha durante alguns minutos até que desapareça.

Não utilizar abrasivos ou ácidos. Nunca utilizar solventes. Apenas limpeza profissional.

Madeira: Limpar o pó regularmente com um pano limpo, macio e seco.

IT

Se aprite la scatola e trovate dei graffi sul divano o sui braccioli, per favore usate un asciugamano per pulirli per diversi minuti finché non si riducono.

Non usare abrasivi o acidi. Non usare mai solventi. Solo pulizia professionale.

Legno: spolverare regolarmente con un panno pulito, morbido e asciutto.

DE

Wenn Sie den Karton öffnen und Kratzer auf dem Sofa oder den Armlehnen finden, verwenden Sie bitte ein Tuch, um den Karton mehrere Minuten lang abzuwischen, bis die Kratzer abgemildert sind.

Scheuernde und säurehaltige Mittel dürfen keinesfalls angewendet werden. Verwenden Sie niemals Lösungsmittel. Nur professionelle Reinigung.

Holz: Regelmäßig mit einem sauberen, weichen und trockenen Tuch abstauben.

CONSEILS D'UTILISATION / CONSEJOS DE USO / DIRECTIONS FOR USE / GEBRUIKSAADVIEZEN / DICAS PARA USAR / CONSIGLI D'USO / VERWENDUNGSHINWEISE

FR

Attention, ne pas s'asseoir sur les accoudoirs. En effet, cela peut entraîner une dégradation du produit, voire des blessures, n'entrant pas dans le cadre de la garantie.

ES

No se siente en los reposabrazos. Esto puede provocar daños en el producto o incluso lesiones, que no están cubiertas por la garantía.

EN

Do not sit on the armrests. Doing so may cause damage to the product or even injury, which is not covered by the warranty.

NL

Ga niet op de armleuningen zitten. Dit kan leiden tot schade aan het product of zelfs letsel, wat niet onder de garantie valt.

PT

Não se sentar nos apoios de braços. Isto pode levar a danos no produto ou mesmo a ferimentos, que não estão cobertos pela garantia.

IT

Non sedersi sui braccioli. Ciò può causare danni al prodotto o addirittura lesioni, che non sono coperte dalla garanzia.

DE

Setzen Sie sich nicht auf die Armlehnen. Dies kann nämlich zu einer Beschädigung des Produkts oder sogar zu Verletzungen führen, die nicht unter die Garantie fallen.

GARANTIE / GARANTÍA / WARRANTY / GARANTIE / GARANTIA / GARANZIA

FR

Sweeek garantit toutes les pièces du produit contre tout vice de fabrication et de matériau pendant une période de 2 ans à compter de la date de réception par le consommateur.

LISTE DES EXCLUSIONS DE GARANTIE

- Le non-respect des conseils d'utilisation du constructeur.

ES

Sweeek garantiza que todas las piezas del producto están libres de defectos de fabricación y materiales durante un periodo de 2 años a partir de la fecha de recepción por parte del consumidor.

LISTA DE EXCLUSIONES DE LA GARANTÍA

- No seguir las instrucciones de uso del fabricante.

EN

Sweeek warrants all parts of the product to be free from defects in workmanship and materials for a period of 2 years from the date of receipt by the consumer.

LIST OF WARRANTY EXCLUSIONS

- Failure to follow the manufacturer's instructions for use.

NL

Sweeek garandeert dat alle onderdelen van het product vrij zijn van fabricage- en materiaalfouten gedurende een periode van 2 jaar vanaf de datum van ontvangst door de consument.

LIJST VAN GARANTIE-UITSLUITINGEN

- Het niet volgen van de gebruiksaanwijzing van de fabrikant.

PT

Sweeek garante que todas as partes do produto estão livres de defeitos de fabrico e materiais durante um período de 2 anos a partir da data da sua recepção pelo consumidor.

LISTA DE EXCLUSÕES DE GARANTIA

- Não seguir as instruções de utilização do fabricante.

IT

Sweeek garantisce che tutte le parti del prodotto sono prive di difetti di lavorazione e di materiali per un periodo di 2 anni dalla data di ricevimento da parte del consumatore.

ELENCO DELLE ESCLUSIONI DALLA GARANZIA

- Mancata osservanza delle istruzioni d'uso del produttore.

DE

Sweeek garantiert für einen Zeitraum von zwei Jahren ab dem Datum des Erhalts durch den Verbraucher, dass alle Teile des Produkts frei von Verarbeitungs- und Materialfehlern sind.

LISTE DER GARANTIEAUSSCHLÜSSE

- Die Nichtbeachtung der Gebrauchshinweise des Herstellers.

MONTAGE / MONTAJE / ASSEMBLY / MONTAGEM / MONTAGGIO

1
x 1

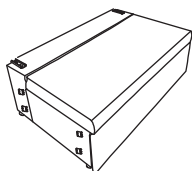

2
x 1

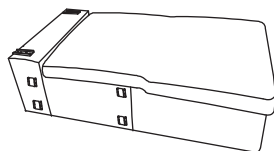

3
x 1

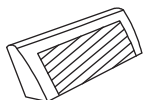

4
x 1

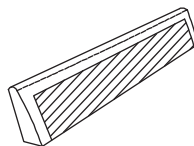

5
x 1

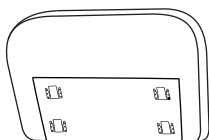

6
x 1

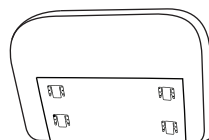

7
x 2



8
x 3

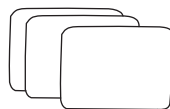

9
x 4

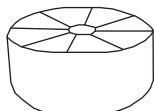

A



M5x4cm

x 4

B



x 1

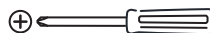

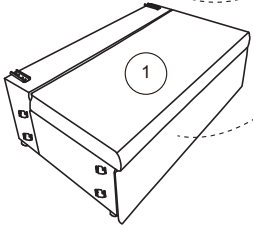
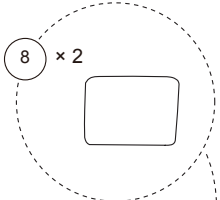
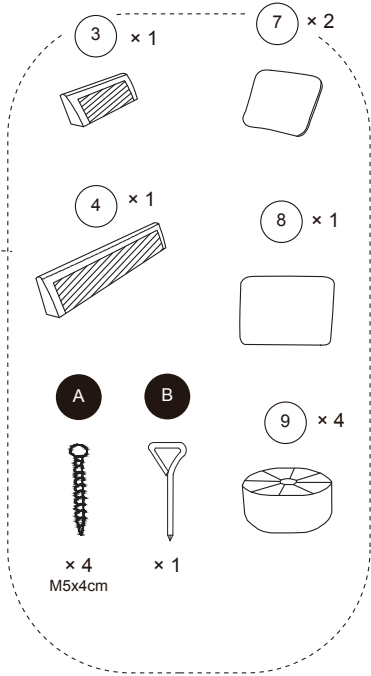
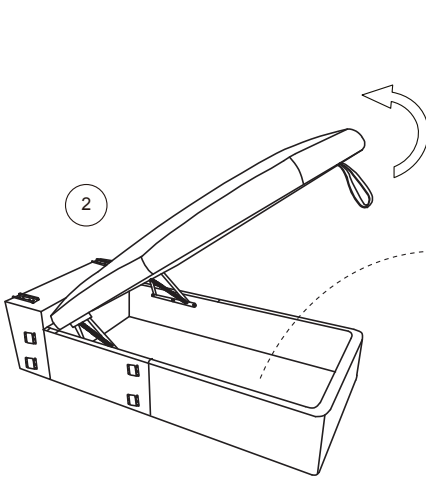

OPTION 1

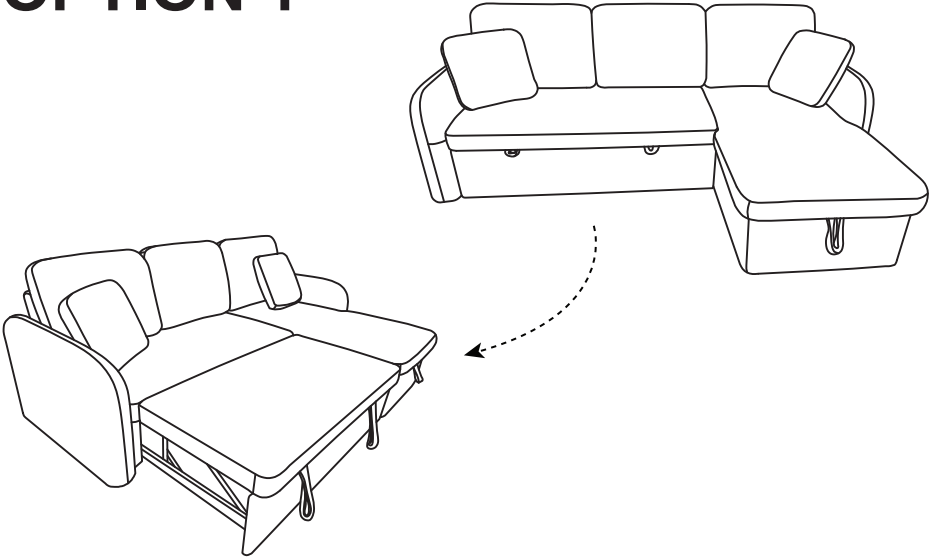

OPTION 2

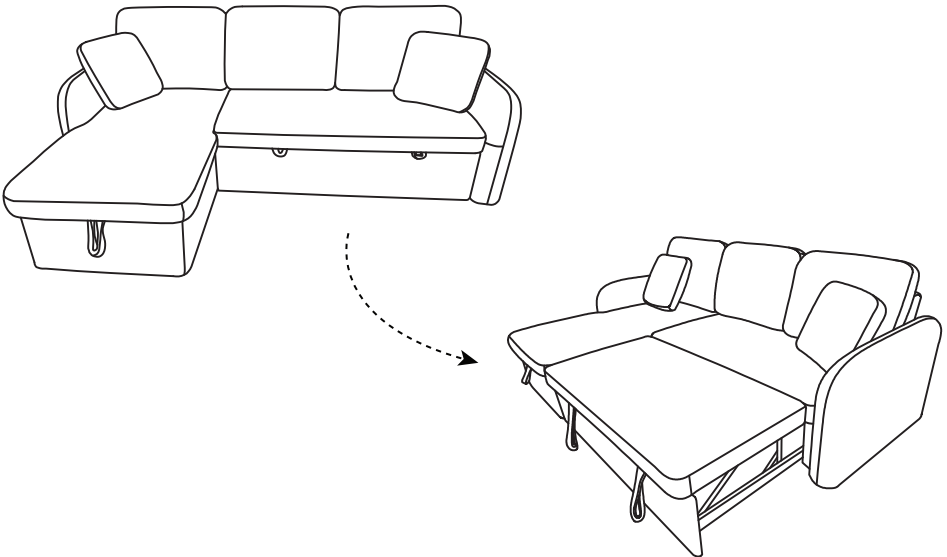

1

A x4
B x1

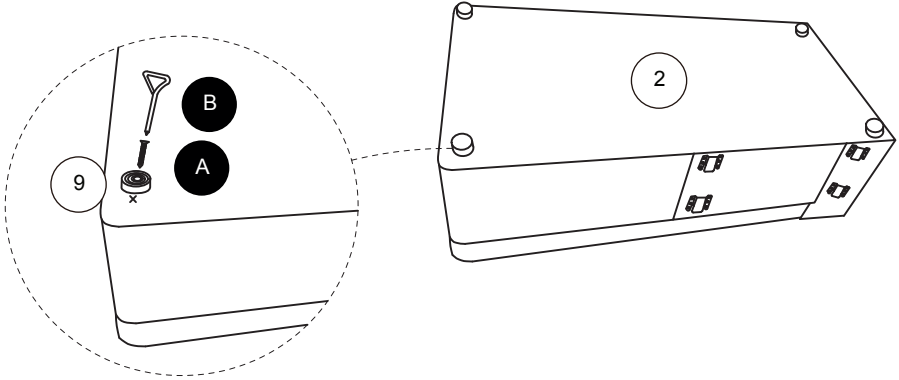

OPTION 1

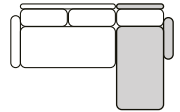

2

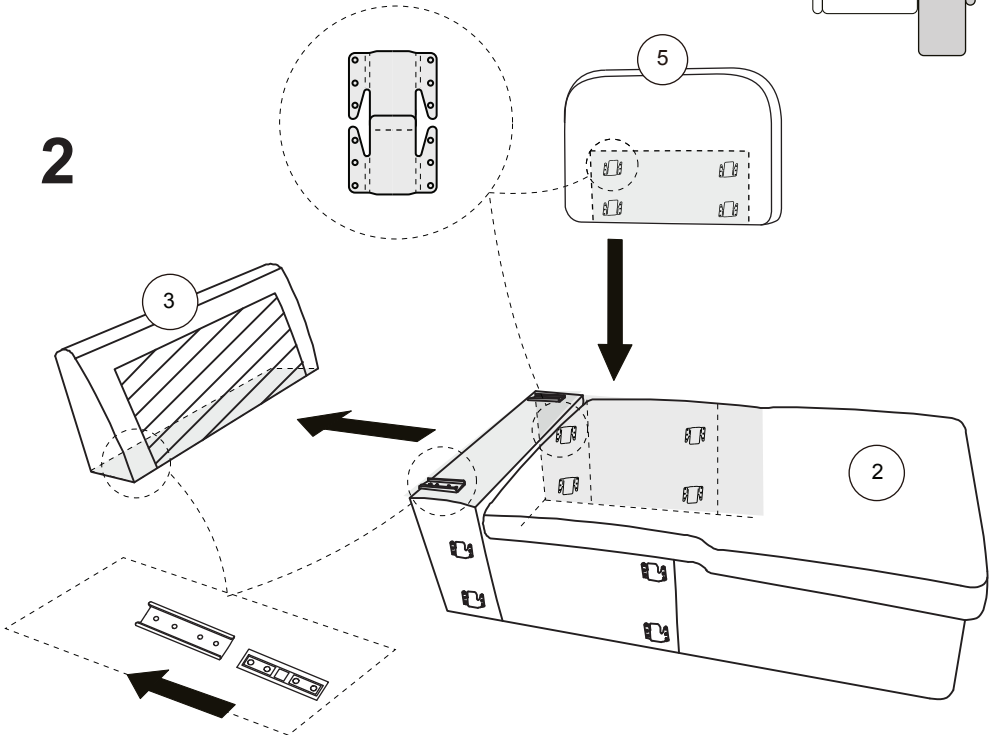

OPTION 2

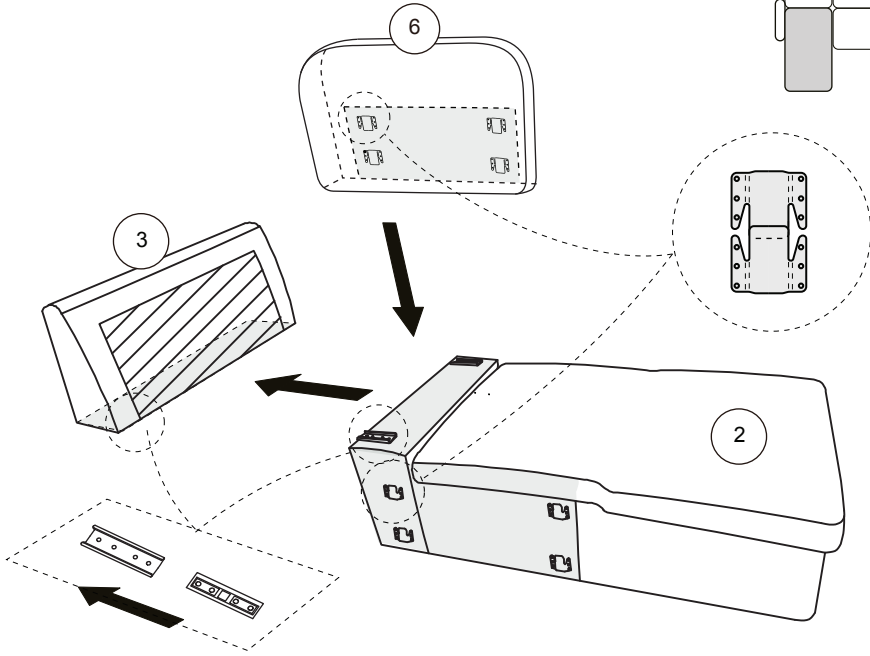
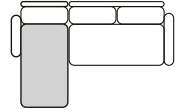

OPTION 1

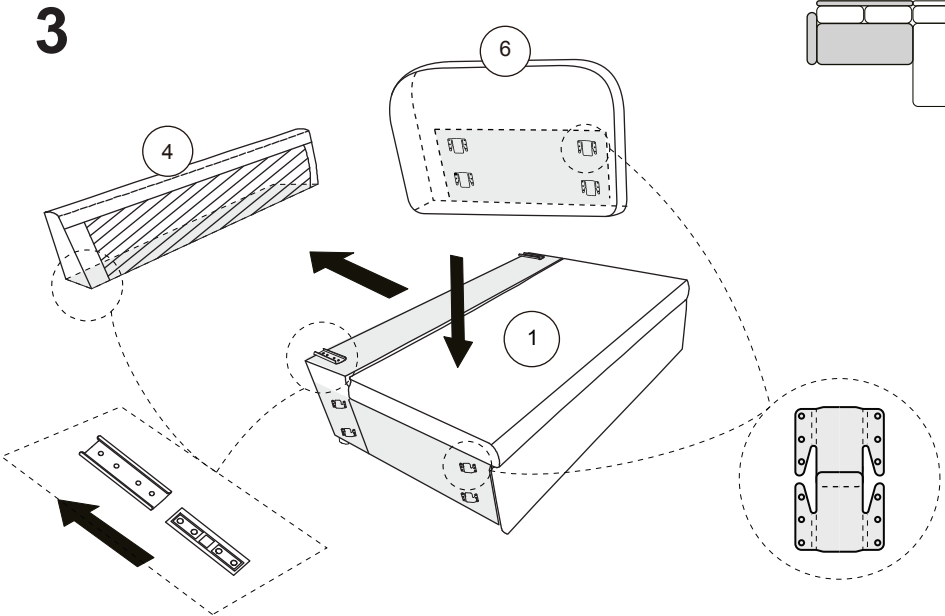
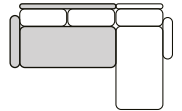

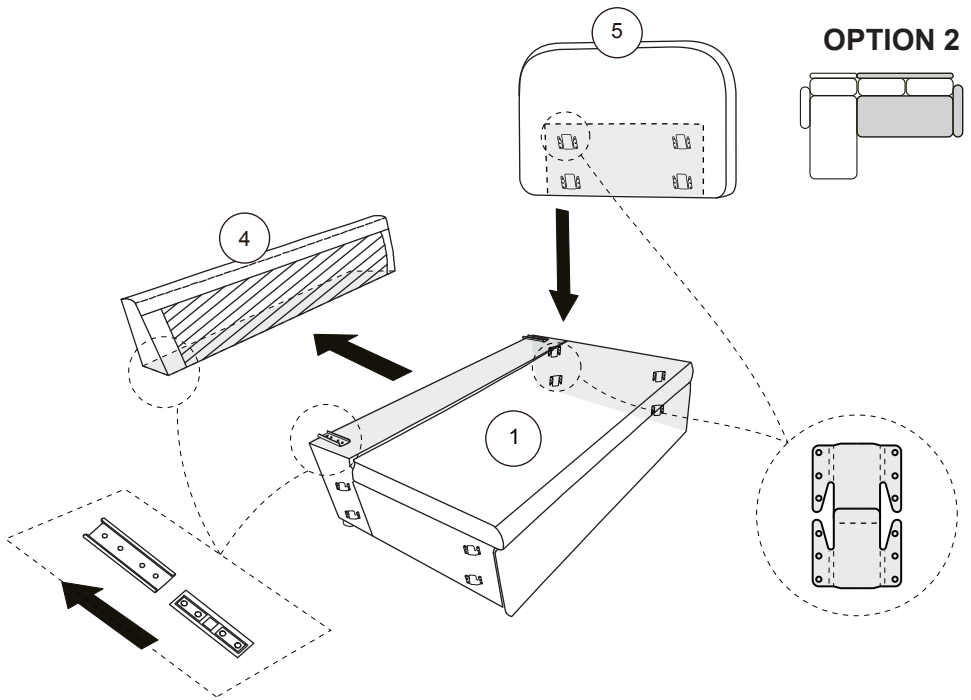

OPTION 2

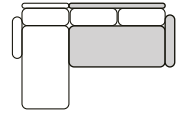

OPTION 1

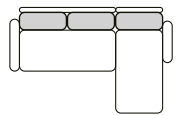

4

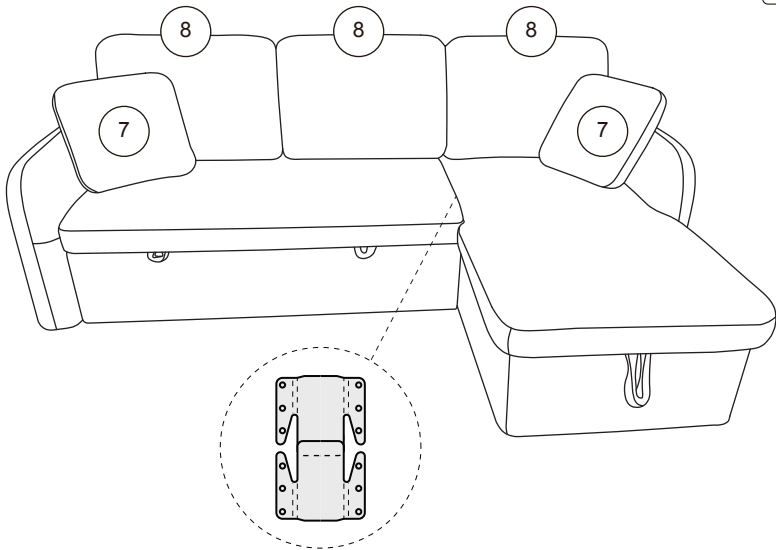

OPTION 2

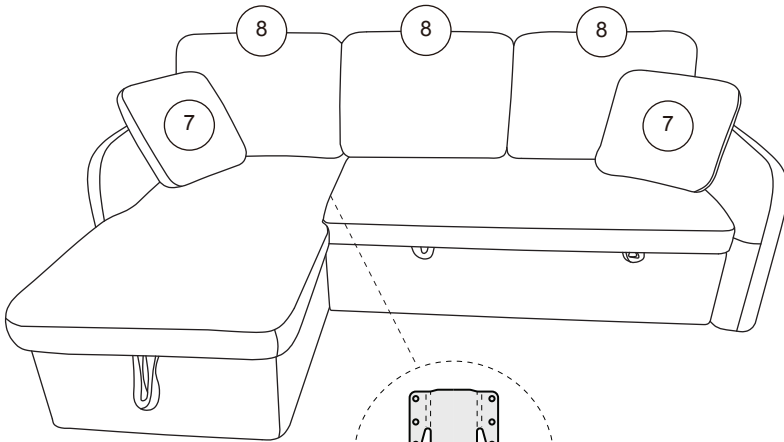
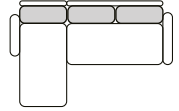

OPTION 1

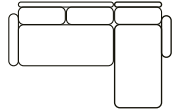

5

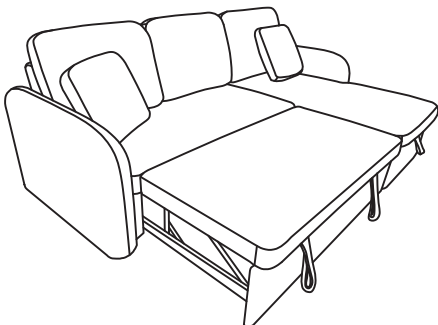
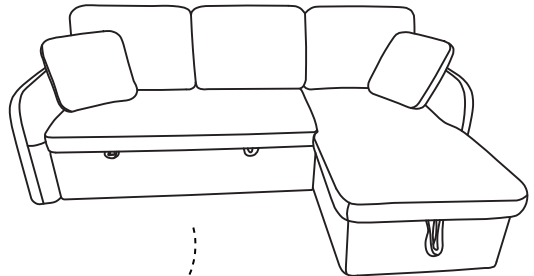

OPTION 2

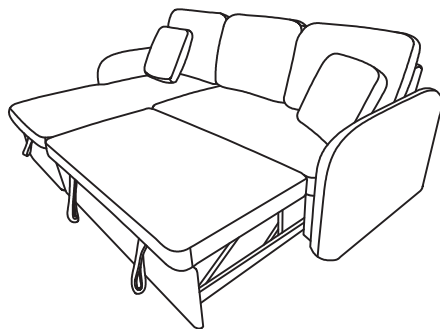
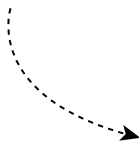
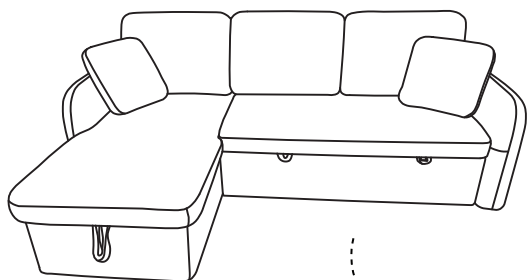
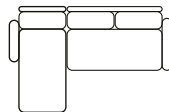

IMPORTÉ PAR WALIBUY SAS
270 avenue de l'Espace, 59118 WAMBRECHIES - FRANCE

IMPORTADO POR WALIBUY SPAIN SL
Avenida de Roma 157, 08011 BARCELONA - ESPAÑA

IMPORTED BY ALICE'S GARDEN UK LTD
23 Copenhagen Street, LONDON N10JB - UNITED KINGDOM

INGEVOERD DOOR WALIBUY SAS
270 avenue de l'Espace, 59118 WAMBRECHIES - FRANKRIJK

IMPORTADO POR WALIBUY SPAIN SL
Avenida de Roma 157, 08011 BARCELONA - SPANHA

IMPORTATO DA WALIBUY ITALIA S.R.L
Via Torino 60, 20123 MILANO - ITALIA

IMPORTIERT VON WALIBUY SAS
270 avenue de l'Espace, 59118 WAMBRECHIES - FRANKREICH

IMPORTOWANE PRZEZ WALIBUY SAS
270 avenue de l'Espace, 59118 WAMBRECHIES - FRANCJA

 SWEEEK ME



SERVICE APRÈS VENTE :

SERVICIO POSTVENTA :

AFTER SALES SERVICE :

AFTER-SALES :

SERVIÇO PÓS-VENDA :

CONTATTO :

CONTACT :

KUNDENDIENST :

SERWIS POGWARANCYJNY :

www.sweeek.help



FR
Donnez ou recyclez
vos meubles.



Association

ou



Magasin

ou



Déchèterie

<https://quefairedemesdechets.fr>