

ISOF1

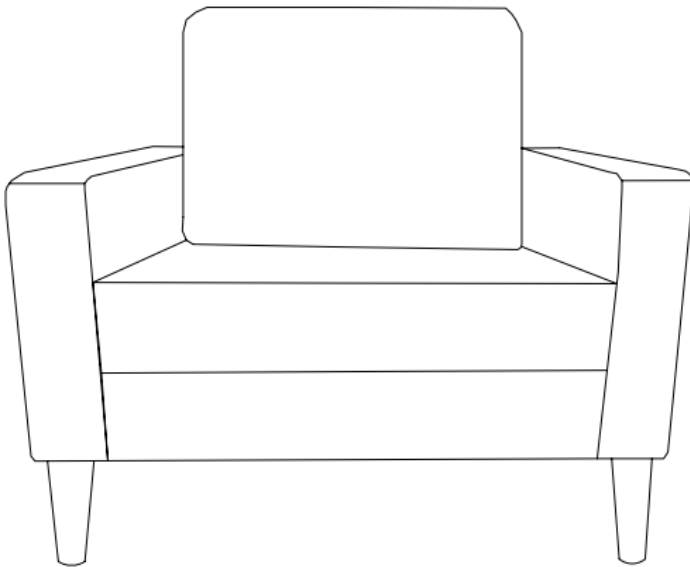

FRANÇAIS

Conseils d'entretien.....	6
Montage.....	7

**IMPORTANT, À CONSERVER
POUR CONSULTATION ULTÉRIEURE :
À LIRE ATTENTIVEMENT**

ESPAÑOL

Instrucciones de uso.....	6
Montaje.....	7

**IMPORTANTE, CONSÉRVELO
PARA FUTURAS REFERENCIAS:
LEA ATENTAMENTE**

ENGLISH

Directions for use.....	6
Assembly.....	7

**IMPORTANT, KEEP FOR FUTURE
REFERENCE: PLEASE READ
CAREFULLY**

NEDERLANDS

Onderhoud.....	6
Montage.....	7

**BELANGRIJK, BEWAAR VOOR
TOEKOMSTIGE REFERENTIE:
ZORGVULDIG LEZEN**

PORTUGUÊS

Instruções de utilização.....	6
Assembleia.....	7

**IMPORTANTE, CONSERVE A
REFERÊNCIA DA FATURA:
LEIA CUIDADOSAMENTE**

ITALIANO

Consigli per la manutenzione.....	6
Montaggio.....	7

**IMPORTANTE, CONSERVARE PER
ULTERIORI CONSULTAZIONI:
LEGGERE ATTENTAMENTE**

Pflegehinweis 6
Montage 7

**WICHTIG, ZUM SPÄTEREN
GEBRAUCH AUFHEBEN UND
SORGFÄLTIG DURCHLESEN**



Poids d'assise maximal : 110kg
Peso asiento máximo : 110kg
Maximum seat weight: 110kg/ 243lbs
Maximale zitplaatsen gewicht: 110kg
Peso máximo do banco: 110kg
Peso massimo area di seduta: 110kg
Maximales Sitzgewicht: 110kg



Garantie : 2 ans
Garantía : 2 años
Warranty: 2 years
Garantie: 2 jaar
Garantía: 2 anos
Garanzia : 2 anni
Garantie: 2 Jahre



Destiné à un usage domestique
Destinado a un uso doméstico
For domestic use only
Bestemd voor huishoudelijk gebruik
Para uso doméstico
Destinato ad un uso domestico
Für den häuslichen Gebrauch

CONSEILS D'ENTRETIEN / INSTRUCCIONES DE USO / DIRECTIONS FOR USE / ONDERHOUD / INSTRUÇÕES DE UTILIZAÇÃO / CONSIGLI PER LA MANUTENZIONE / PFLEFEBINWELS

FR

Dépoussiérer régulièrement avec un chiffon propre, doux et sec.
Proscrire tout abrasif et produits acides. Ne jamais employer de solvants.
Nettoyage professionnel uniquement.
Ne pas monter sur la chaise / Ne pas se balancer

ES

Quitar el polvo regularmente con un paño limpio, suave y seco.
No utilice productos abrasivos o ácidos. No utilice nunca disolventes de limpieza
Sólo se debe realizar una limpieza profesional..
No se ponga de pie sobre la silla ni se columpie en ella.

EN

Regularly dust with a clean, soft and dry cloth.
Do not use any abrasive or acidic products. Never use cleaning solvents.
Professional cleaning only.
Do not stand up on the chair and/or swing on the chair.

NL

Stof regelmatig af met een schone, zachte en droge doek. Alleen
Sluit alle schurende en zure producten uit. Gebruik nooit oplosmiddelen.
Alleen professionele reiniging.
Ga niet op de stoel staan/Niet schommelen.

PT

Pó regularmente com um espanador limpo, macio e seco.
Proibir qualquer esfregão e produtos ácidos. Nunca utilizar solvente de limpeza.
Apenas limpeza profissional.
Não se levantar sobre a cadeira e/ou balançar sobre a cadeira.





IT

Spolverare regolarmente con un panno pulito, morbido e asciutto.
Non usare prodotti abrasivi o acidi. Non usare mai solventi.
Solo pulizia professionale.
Non salire sulla sedia / Non dondolare.

DE

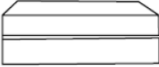
Regelmäßig mit einem sauberen, weichen und trockenen Tuch abstauben.
Scheuernde und säurehaltige Mittel dürfen keinesfalls angewendet werden.
Verwenden Sieniemals Lösungsmittel.
Nur professionelle Reinigung.
Nicht auf den Stuhl stellen / Nicht schaukeln.

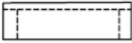
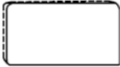
MONTAGE / MONTAJE / ASSEMBLY / ASSEMBLEIA / MONTAGGIO

A	B1	B2
 X 1	 X 1	 X 1
C	D	E
 X 1	 X 1	 X 4

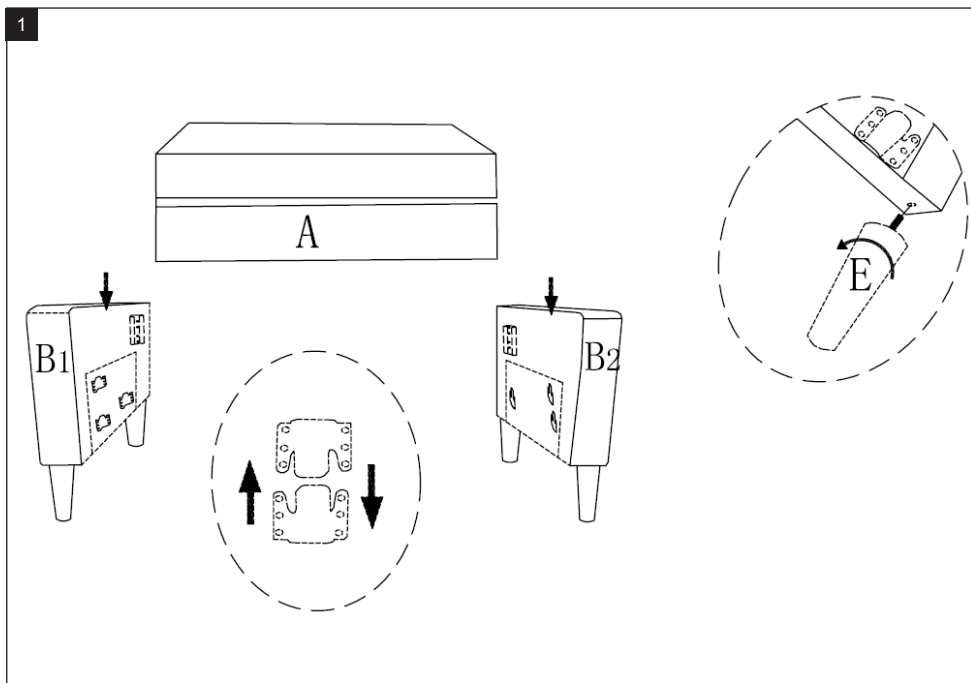

FR Attention, certaines pièces peuvent se trouver sous l'assise.

ES Tenga en cuenta que algunas piezas pueden estar situadas bajo el asiento.

EN Warning: Some pieces might be under the seat

NL Let op: sommige onderdelen kunnen zich onder de zitting bevinden.

PT É favor notar que algumas partes podem estar localizadas debaixo do assento.

IT Si prega di notare che alcune parti possono trovarsi sotto il sedile.

DE Bitte beachten Sie, dass sich einige Teile unter dem Sitz befinden können.

2

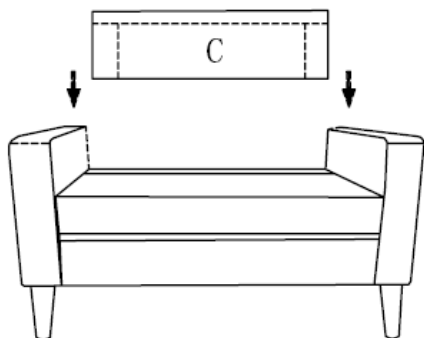
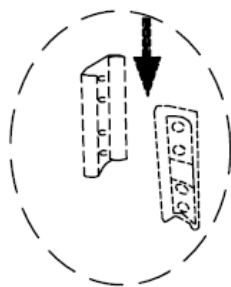

3

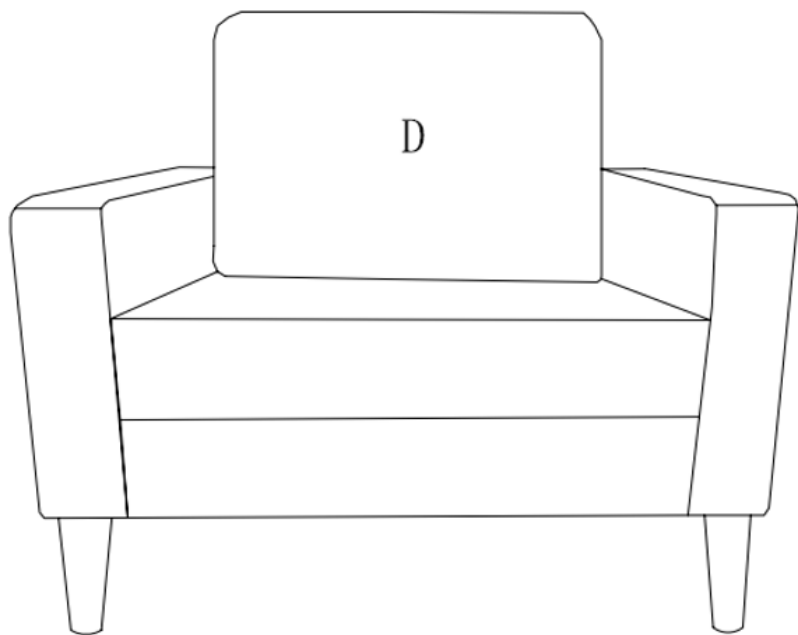

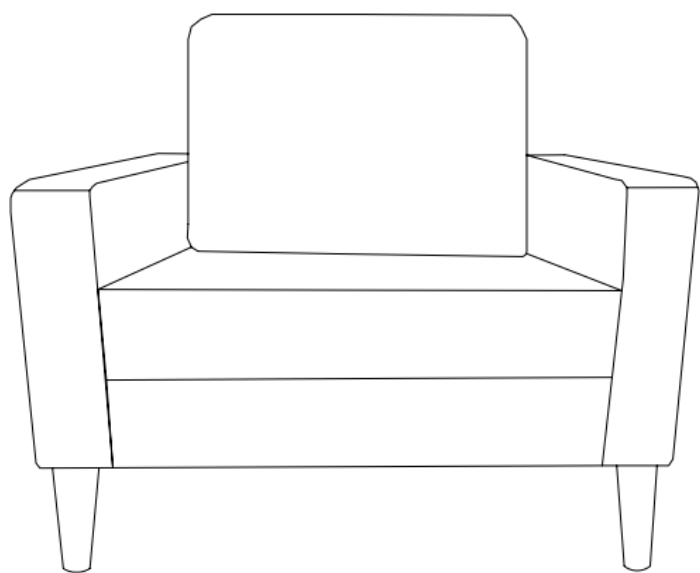

IMPORTÉ PAR WALIBUY SAS
270 avenue de l'Espace, 59118 WAMBRECHIES - FRANCE
Service après vente : sav.alicesgarden.fr - sav.alicesgarden.be

IMPORTADO POR WALIBUY SPAIN SL
Carrer de Mallorca 289, Entresuelo 2, 08037 BARCELONA - ESPAÑA
Servicio postventa : alicesgarden.es/cms/contacto

IMPORTED BY ALICE'S GARDEN UK LTD
Office G07, Dowgate Hill House, EC4R 2SU London - UNITED KINGDOM
After sales service: alicesgarden.co.uk/cms/contact-us

INGEVOERD DOOR WALIBUY SAS
270 avenue de l'Espace, 59118 WAMBRECHIES - FRANKRIJK
After-sales : aftersales.alicesgarden.nl - aftersales.alicesgarden.be

IMPORTADO PARA WALIBUY SPAIN SL
Carrer de Mallorca 289, Entresuelo 2, 08037 BARCELONA - ESPAÑA
Serviço pós-venda : alicesgarden.pt/cms/contacto

IMPORTATO DA WALIBUY ITALIA S.R.L
Via Torino 60, 20123 MILANO - ITALIA
Contatto : contatto@alicesgarden.it

IMPORTED BY ALICE'S GARDEN OUTDOOR PTY LTD
135-153 New South Head Road, Edgecliff NSW 2027 - AUSTRALIA
Contact : service@alicesgarden.com.au

IMPORTIERT VON WALIBUY SAS
270 AVENUE DE L'ESPACE, 59118 WAMBRECHIES - FRANKREICH
Kundendienst : kundenservice@alicesgarden.de
