

ISOPCBCLX2



FRANÇAIS

Conseils d'entretien	6
Conseils d'utilisation	7
Garantie.....	8
Montage.....	9

**IMPORTANT, À CONSERVER
POUR CONSULTATION ULTÉRIEURE :
À LIRE ATTENTIVEMENT**

ESPAÑOL

Consejos de mantenimiento	6
Consejos de uso.....	7
Garantía.....	8
Montaje.....	9

**IMPORTANTE, CONSÉRVELO
PARA FUTURAS REFERENCIAS:
LEA ATENTAMENTE**

ENGLISH

Directions for maintenance.....	6
Directions for use.....	7
Warranty.....	8
Assembly.....	9

**IMPORTANT, RETAIN FOR FUTURE
REFERENCE: PLEASE READ
CAREFULLY**

NEDERLANDS

Onderhoud.....	6
Gebruiksadviezen.....	7
Garantie.....	8
Montage.....	9

**BELANGRIJK, BEWAAR VOOR
TOEKOMSTIGE REFERENTIE:
ZORGVULDIG LEZEN**

PORTUGUÊS

Dicas para cuidar.....	6
Dicas para usar	7
Garantia.....	8
Montagem.....	9

**IMPORTANTE, CONSERVE A
REFERÊNCIA DA FATURA:
LEIA CUIDADOSAMENTE**

ITALIANO

Consigli per la manutenzione	6
Consigli d'uso	7
Garanzia.....	8
Montaggio.....	9

**IMPORTANTE, CONSERVARE PER
ULTERIORI CONSULTAZIONI:
LEGGERE ATTENTAMENTE**

DEUTSCH

Pflegehinweise	6
Verwendungshinweise.....	7
Garantie.....	8
Montage	9

**WICHTIG, FÜR SPÄTEREN
GEBRAUCH AUFBEWAHREN:
BITTE SORGFÄLTIG LESEN**



Destiné à un usage domestique
Destinado a un uso doméstico
For domestic use
Bestemd voor huishoudelijk gebruik
Para uso doméstico
Destinato ad un uso domestico
Nur für den Privatgebrauch vorgesehen



Attention : risques de blessures
Cuidado : riesgo de lesión
Warning : risk of injuries
Waarschuwing: risico op verwondigen
Cuidado: risco de ferimentos
Attenzione : rischio infortunio
Warnung: Verletzungsgefahr



Garantie : 2 ans
Garantía : 2 años
Warranty: 2 years
Garantie: 2 jaar
Garantia: 2 anos
Garanzia : 2 anni
Garantie: 2 Jahre



Poids maximal : 110kg
Peso máximo : 110kg
Maximum weight : 110kg
Maximale gewicht: 110kg
Peso máximo: 110kg
Peso massimo: 110kg
Maximale Belastbarkeit: 110kg

CONSEILS D'ENTRETIEN / CONSEJOS DE USO / DIRECTIONS FOR MAINTENANCE / ONDERHOUD / DICAS PARA CUIDAR / CONSIGLI PER LA MANUTENZIONE / PFLEGEHINWEISE

FR

Bois: Dépoussiérer régulièrement avec un chiffon propre, doux et sec. Proscrire tout abrasif et produits acides. Ne jamais employer de solvants. Nettoyage professionnel uniquement.

ES

Quitar el polvo regularmente con un paño limpio, suave y seco. No utilice productos abrasivos o ácidos. No utilice nunca disolventes de limpieza. Sólo se debe realizar una limpieza profesional.

EN

Regularly dust with a clean, soft and dry cloth. Do not use any abrasive or acidic products. Never use cleaning solvents. Professional cleaning only.

NL

Stof regelmatig af met een schone, zachte en droge doek. Alleen Sluit alle schurende en zure producten uit. Gebruik nooit oplosmiddelen. Alleen professionele reiniging.

PT

Pó regularmente com um espanador limpo, macio e seco. Proibir qualquer esfregão e produtos ácidos. Nunca utilizar solvente de limpeza. Apenas limpeza profissional.

IT

Spolverare regolarmente con un panno pulito, morbido e asciutto. Non usare prodotti abrasivi o acidi. Non usare mai solventi. Solo pulizia professionale.

DE

Regelmäßig mit einem sauberen, weichen und trockenen Tuch abstauben. Scheuernde und säurehaltige Mittel dürfen keinesfalls angewendet werden. Verwenden Sie niemals Lösungsmittel. Nur professionelle Reinigung.

CONSEILS D'UTILISATION / CONSEJOS DE USO / DIRECTIONS FOR USE / GEBRUIKSAADVIEZEN / DICAS PARA USAR / CONSIGLI D'USO / VERWENDUNGSHINWEISE

FR

Ne pas monter sur la chaise / Ne pas se balancer. En effet, cela peut entraîner une dégradation du produit, voire des blessures, n'entrant pas dans le cadre de la garantie.

ES

No se ponga de pie sobre la silla ni se columpie en ella. Esto puede provocar daños en el producto o incluso lesiones, que no están cubiertas por la garantía.

EN

Do not stand up on the chair and/or swing on the chair. Doing so may cause damage to the product or even injury, which is not covered by the warranty.

NL

Ga niet op de stoel staan/Niet schommelen. Dit kan leiden tot schade aan het product of zelfs letsel, wat niet onder de garantie valt.

PT

Não se levantar sobre a cadeira e/ou balançar sobre a cadeira. Isto pode levar a danos no produto ou mesmo a ferimentos, que não estão cobertos pela garantia.

IT

Non salire sulla sedia / Non dondolare. Ciò può causare danni al prodotto o addirittura lesioni, che non sono coperte dalla garanzia.

DE

Nicht auf den Stuhl stellen / Nicht schaukeln. Dies kann nämlich zu einer Beschädigung des Produkts oder sogar zu Verletzungen führen, die nicht unter die Garantie fallen.

GARANTIE / GARANTÍA / WARRANTY / GARANTIA / GARANZIA

FR

Sweeek garantit toutes les pièces du produit contre tout vice de fabrication et de matériau pendant une période de 2 ans à compter de la date de réception par le consommateur.

LISTE DES EXCLUSIONS DE GARANTIE

- Le non-respect des conseils d'utilisation du constructeur.

ES

Sweeek garantiza que todas las piezas del producto están libres de defectos de fabricación y materiales durante un periodo de 2 años a partir de la fecha de recepción por parte del consumidor.

LISTA DE EXCLUSIONES DE LA GARANTÍA

- No seguir las instrucciones de uso del fabricante.

EN

Sweeek warrants all parts of the product to be free from defects in workmanship and materials for a period of 2 years from the date of receipt by the consumer.

LIST OF WARRANTY EXCLUSIONS

- Failure to follow the manufacturer's instructions for use.

NL

Sweeek garandeert dat alle onderdelen van het product vrij zijn van fabricage- en materiaalfouten gedurende een periode van 2 jaar vanaf de datum van ontvangst door de consument.

LIJST VAN GARANTIE-UITSLUITINGEN

- Het niet volgen van de gebruiksaanwijzing van de fabrikant.

PT

Sweeek garante que todas as partes do produto estão livres de defeitos de fabrico e materiais durante um período de 2 anos a partir da data da sua recepção pelo consumidor.

LISTA DE EXCLUSÕES DE GARANTIA

- Não seguir as instruções de utilização do fabricante.

IT

Sweeek garantisce che tutte le parti del prodotto sono prive di difetti di lavorazione e di materiali per un periodo di 2 anni dalla data di ricevimento da parte del consumatore.

ELENCO DELLE ESCLUSIONI DALLA GARANZIA

- Mancata osservanza delle istruzioni d'uso del produttore.

DE

Sweeek garantiert für einen Zeitraum von zwei Jahren ab dem Datum des Erhalts durch den Verbraucher, dass alle Teile des Produkts frei von Verarbeitungs- und Materialfehlern sind.

LISTE DER GARANTIEAUSSCHLÜSSE

- Die Nichtbeachtung der Gebrauchshinweise des Herstellers.

MONTAGE / MONTAJE / ASSEMBLY / MONTAGEM / MONTAGGIO

1
× 1

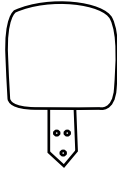

3
× 1

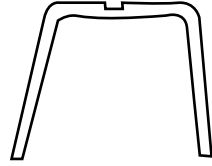

2
× 1



4
× 1

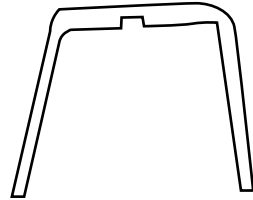

M6x32mm
× 1

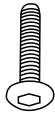

M6x40mm
× 2

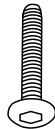

M6x45mm
× 4

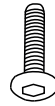

M6x35mm
× 1



× 8



× 8



× 1

1

- B x1
- D x1
- E x2
- F x3
- G x1

X2

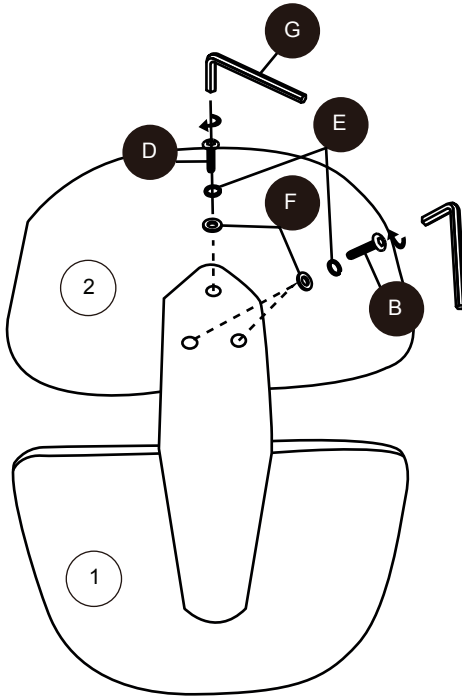

2

- A x1
- E x1
- F x1
- G x1

X2

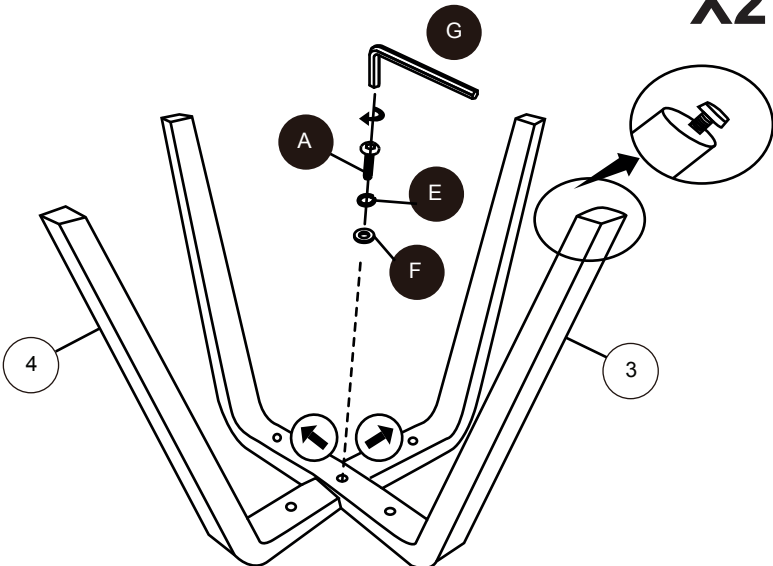

3

C x4
E x4
F x4
G x1

X2

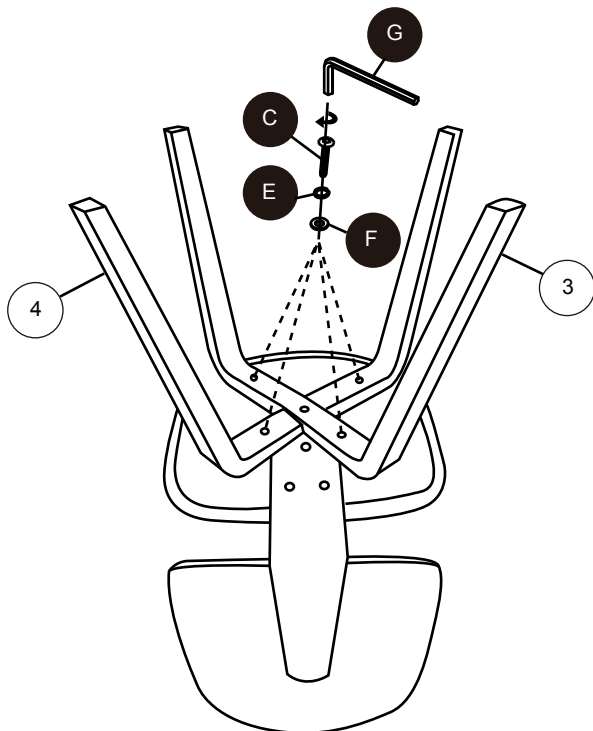

4

X2

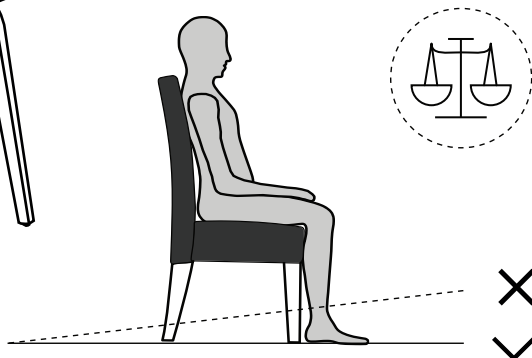

5

X2



IMPORTÉ PAR WALIBUY SAS
270 avenue de l'Espace, 59118 WAMBRECHIES - FRANCE

IMPORTADO POR WALIBUY SPAIN SL
Calle Mallorca 289, Entresuelo 2, 08037 BARCELONA - ESPAÑA

IMPORTED BY ALICE'S GARDEN UK LTD
23 Copenhagen Street, LONDON N10JB - UNITED KINGDOM

INGEVOERD DOOR WALIBUY SAS
270 avenue de l'Espace, 59118 WAMBRECHIES - FRANKRIJK

IMPORTADO POR WALIBUY SPAIN SL
Calle Mallorca 289, Entresuelo 2, 08037 BARCELONA - ESPANHA

IMPORTATO DA WALIBUY ITALIA S.R.L
Via Torino 60, 20123 MILANO - ITALIA

IMPORTED BY ALICE'S GARDEN OUTDOOR PTY LTD
Level 22,101 Grafton Street, Bondi Junction NSW, 2022 - AUSTRALIA

IMPORTIERT VON WALIBUY SAS
270 avenue de l'Espace, 59118 WAMBRECHIES - FRANKREICH



SWEEEK ME



SERVICE APRÈS VENTE :
SERVICIO POSTVENTA :
AFTER SALES SERVICE :
AFTER-SALES :
SERVIÇO PÓS-VENDA :
CONTATTO :
CONTACT :
KUNDENDIENST :

www.sweeek.help



FR

**Donnez ou recyclez
vos meubles.**



Association

ou



Magasin

ou



Déchèterie

<https://quefairedemesdechets.fr>