

IBASIKS2X4

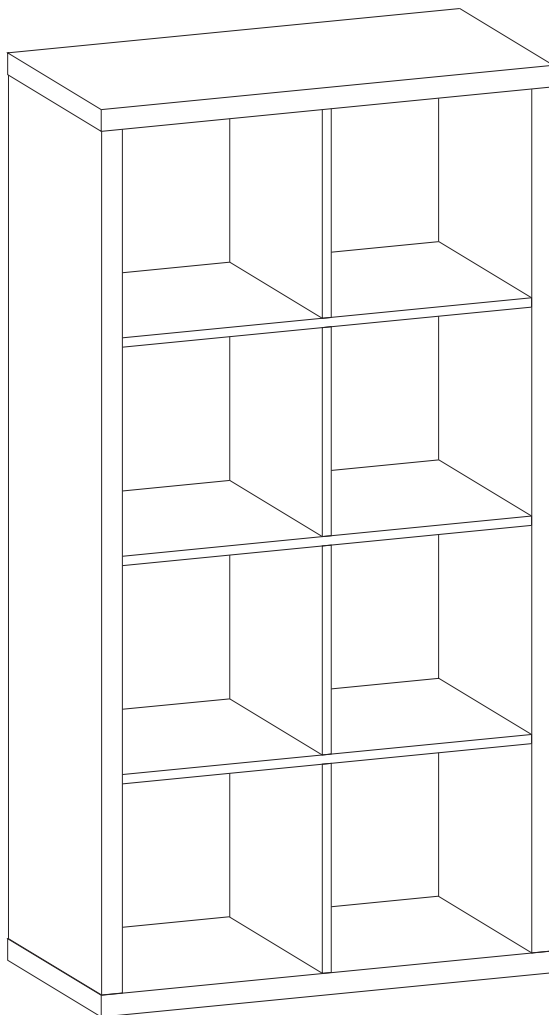

swееek.fr - swееek.be - swееek.es - swееek.nl - swееek.co.uk  
swееek.pt - swееek.it - swееek.de - swееek.pl

**FRANÇAIS**

Conseils d'entretien.....	6
Conseils d'utilisation.....	7
Avertissements.....	8
Garantie.....	9
Montage.....	10

**IMPORTANT, À CONSERVER  
POUR CONSULTATION ULTÉRIEURE :  
À LIRE ATTENTIVEMENT**

**ESPAÑOL**

Consejos de mantenimiento.....	6
Consejos de uso.....	7
Advertencia.....	8
Garantía.....	9
Montaje.....	10

**IMPORTANTE, CONSÉRVELO  
PARA FUTURAS REFERENCIAS:  
LEA ATENTAMENTE**

**ENGLISH**

Directions for maintenance.....	6
Directions for use.....	7
Warning.....	8
Warranty.....	9
Assembly.....	10

**IMPORTANT, RETAIN FOR FUTURE  
REFERENCE: PLEASE READ  
CAREFULLY**

## NEDERLANDS

Onderhoud.....	6
Gebruiksadviezen .....	7
Waarschuwingen .....	8
Garantie.....	9
Montage.....	10

**BELANGRIJK, BEWAAR VOOR  
TOEKOMSTIGE REFERENTIE:  
ZORGVULDIG LEZEN**

## PORTUGUÊS

Dicas para cuidar.....	6
Dicas para usar .....	7
Advertência.....	8
Garantia.....	9
Assembleia.....	10

**IMPORTANTE, CONSERVE A  
REFERÊNCIA DA FATURA:  
LEIA CUIDADOSAMENTE**

## ITALIANO

Consigli per la manutenzione .....	6
Consigli d'uso .....	7
Avvertenze.....	8
Garanzia.....	9
Montaggio.....	10

**IMPORTANTE, CONSERVARE PER  
ULTERIORI CONSULTAZIONI:  
LEGGERE ATTENTAMENTE**

## DEUTSCH

Pflegehinweise .....	6
Verwendungshinweise.....	7
Warnhinweise .....	8
Garantie.....	9
Montage .....	10

**WICHTIG, FÜR SPÄTEREN  
GEBRAUCH AUFBEWAHREN:  
BITTE SORGFÄLTIG LESEN**



Garantie : 2 ans  
Garantía : 2 años  
Warranty: 2 years  
Garantie: 2 jaar  
Garantia: 2 anos  
Garanzia : 2 anni  
Garantie: 2 Jahre



Destiné à un usage domestique  
Destinado a un uso doméstico  
For domestic use only  
Bestemd voor huishoudelijk gebruik  
Para uso doméstico  
Destinato ad un uso domestico  
Nur für den Privatgebrauch vorgesehen



**Attention** : risques de blessures  
**Cuidado** : riesgo de lesión  
**Warning** : risk of injuries  
**Waarschuwing**: risico op verwondigen  
**Cuidado**: risco de ferimentos  
**Attenzione** : rischio infortunio  
**Warnung**: Verletzungsgefahr

## CONSEILS D'ENTRETIEN / CONSEJOS DE MANTENIMIENTO / DIRECTIONS FOR MAINTENANCE / ONDERHOUD / DICAS PARA CUIDAR / CONSIGLI PER LA MANUTENZIONE / PFLEGEHINWEISE

---

FR

Bois: Dépoussiérer régulièrement avec un chiffon propre, doux et sec.  
Proscrire tout abrasif et produits acides. Ne jamais employer de solvants.

ES

Madera: Quitar el polvo regularmente con un paño limpio, suave y seco.  
No utilice productos abrasivos o ácidos. No utilice nunca disolventes de limpieza.

EN

Wood: Regularly dust with a clean, soft and dry cloth.  
Do not use any abrasive or acidic products. Never use cleaning solvents.

NL

Hout: Stof regelmatig af met een schone, zachte en droge doek.  
Sluit alle schurende en zure producten uit. Gebruik nooit oplosmiddelen.

PT

Madeira: Pó regularmente com um espanador limpo, macio e seco.  
Proibir qualquer esfregão e produtos ácidos. Nunca utilizar solvente de limpeza.

IT

Legno: Spolverare regolarmente con un panno pulito, morbido e asciutto.  
Non usare prodotti abrasivi o acidi. Non usare mai solventi.

DE

Holz: Regelmäßig mit einem sauberen, weichen und trockenen Tuch abstauben.  
Keine Scheuermittel und säurehaltige Produkte verwenden. Verwenden Sie niemals Lösungsmittel.

# CONSEILS D'UTILISATION / CONSEJOS DE USO / DIRECTIONS FOR USE / GEBRUIKSAADVIEZEN / DICAS PARA USAR / CONSIGLI D'USO / VERWENDUNGSHINWEISE

---

FR

Pour des raisons de stabilité, et afin de préserver les pas de vis d'un serrage de travers, il est impératif d'assembler manuellement tous les éléments, et de serrer toutes les vis à la main dans un premier temps. Une fois l'assemblage terminé, vous pouvez procéder au serrage de la visserie de manière plus ferme.

Attention, ne pas s'asseoir sur le produit. En effet, cela peut entraîner une dégradation du produit, voire des blessures, n'entrant pas dans le cadre de la garantie.

ES

Para garantizar la estabilidad y evitar que las roscas de los tornillos se deformen, es imprescindible empezar por montar y atornillar cada pieza a mano. Una vez completado el montaje, se puede proceder a apretar los tornillos con mayor firmeza.

No se siente sobre el producto. De lo contrario, el producto podría resultar dañado o incluso sufrir lesiones, lo que no está cubierto por la garantía.

EN

To ensure stability and in order to prevent the screw threads from becoming deformed, it is essential to start by assembling and screwing in each piece by hand. Once the assembly is complete, you can proceed to tighten the screws more firmly.

Do not sit on the product. Doing so may result in damage to the product or even injury, which is not covered by the warranty.

NL

Omwille van de stabiliteit en om doordraaien te voorkomen, is het van cruciaal belang om alle elementen handmatig te monteren en alle schroeven in eerste instantie met de hand aan te halen. Na de montage kunt u de schroeven steviger vastzetten.

Ga niet op het product zitten. Dit kan leiden tot schade aan het product of zelfs letsel, wat niet onder de garantie valt.

PT

Per ragioni di stabilità e per proteggere le filettature delle viti da un errato serraggio, è imperativo assemblare tutti gli elementi a mano e stringere tutte le viti a mano all'inizio.

Una volta completato il montaggio, le viti possono essere serrate più saldamente.

Não se sentar sobre o produto. Fazê-lo pode resultar em danos no produto ou mesmo em ferimentos, que não estão cobertos pela garantia.

IT

Per ragioni di stabilità e per proteggere le filettature delle viti da un errato serraggio, è imperativo assemblare tutti gli elementi a mano e stringere tutte le viti a mano all'inizio.

Una volta completato il montaggio, le viti possono essere serrate più saldamente.

Non sedersi sul prodotto. Ciò potrebbe causare danni al prodotto o addirittura lesioni, che non sono coperte dalla garanzia.

DE

Aus Stabilitätsgründen und um ein Überdrehen der Gewinde zu verhindern, müssen unbedingt alle Komponenten manuell zusammengebaut und alle Schrauben zuerst von Hand angezogen werden. Sobald die Montage abgeschlossen ist, können Sie die Schrauben fester anziehen.

Setzen Sie sich nicht auf das Produkt. Dies kann nämlich zu einer Beschädigung des Produkts oder sogar zu Verletzungen führen, die nicht unter die Garantie fallen.

# AVERTISSEMENTS / WAARSCHUWINGEN / WARNHINWEISE / WARNING / ADVERTENCIA / ADVERTÊNCIA / AVVERTENZE

---

FR

**ATTENTION :** Risque de blessure grave ou mortelle en cas de basculement du meuble. Pour éviter que le meuble ne bascule, il faut le fixer au mur de façon permanente à l'aide des pièces incluses pour la fixation. Les vis et chevilles ne sont pas incluses car leur choix dépend du matériau du mur sur lequel est fixé le meuble. Utilisez des vis et chevilles adaptées au matériau du mur.

ES

**PRECAUCIÓN:** Riesgo de lesiones mortales o graves en caso de que el mueble se vuelque. Para evitar que el mueble se caiga, debe fijarlo a la pared de forma permanente con las piezas de fijación incluidas. Los tornillos y tacos no están incluidos, ya que la selección de estas piezas depende del material de la pared en la que se fijará el mueble. Utilice los tornillos y tacos adecuados para el material de su pared.

EN

**CAUTION:** Risk of mortal or serious injuries in case of the furniture toppling over. To avoid the furniture falling, you must fix it to the wall permanently with the included fixing pieces. Screws and dowels are not included, as the selection of these parts is dependent on the wall material that the furniture will be fixed to. Use the correct screws and dowels for your wall material.

NL

**WAARSCHUWING :** Wanneer meubels omvallen, kaner ernstig of levens bedreigend beklemmingsletsel ontstaan. Om te voorkomen dat dit meubel omvalt, dient dit permanent met de meegeleverde wandbevestigingen aan de wand te worden bevestigd. Bevestigingsbeslag voor de wand is niet inbegrepen, aangezien verschillende soorten bevestigingsbeslag dat geschikt is voor de wanden in je huis.

PT

**CUIDADO:** Riscos de ferimentos mortais ou graves em caso de tombamento do mobiliário. Para evitar o tombamento do mobiliário, é necessário fixá-lo permanentemente na parede com as peças de fixação incluídas. Os parafusos e cavilhas não estão incluídos, a sua escolha depende do material da parede em que o mobiliário será fixado. Utilizar parafusos e cavilhas adaptados de acordo com o material da parede.

IT

**ATTENZIONE:** rischio di lesioni gravi o morte se il mobile si rovescia. Per evitare che i mobili si ribaltino, devono essere fissati in modo permanente alla parete utilizzando gli elementi di fissaggio inclusi. Viti e tasselli non sono inclusi perché la loro scelta dipende dal materiale del muro a cui il mobile è attaccato. Usare viti e tasselli adatti al materiale della parete.

DE

**ACHTUNG :** Wenn Möbelstücke umkippen, kann dies zu ernststen oder lebensgefährlichen Verletzungen führen. Um zu verhindern, dass dieses Möbelstück umkippt, muss es mit den angefügten Teilen zur Wandbefestigung fest an der Wand verankert werden. Schrauben und Dübel sind nicht angefügt, da ihre Auswahl von dem Material der Wand abhängt, an der das Möbelstück befestigt werden soll. Wählen Sie Schrauben und Dübel aus, die für Ihre Wand geeignet sind



# GARANTIE / GARANTÍA / WARRANTY / GARANTIA / GARANZIA

---

FR

Sweeek garantit toutes les pièces du produit contre tout vice de fabrication et de matériau pendant une période de 2 ans à compter de la date de réception par le consommateur.

## LISTE DES EXCLUSIONS DE GARANTIE

- Le non-respect des conseils d'utilisation du constructeur.

ES

Sweeek garantiza que todas las piezas del producto están libres de defectos de fabricación y materiales durante un periodo de 2 años a partir de la fecha de recepción por parte del consumidor.

## LISTA DE EXCLUSIONES DE LA GARANTÍA

- No seguir las instrucciones de uso del fabricante.

EN

Sweeek warrants all parts of the product to be free from defects in workmanship and materials for a period of 2 years from the date of receipt by the consumer.

## LIST OF WARRANTY EXCLUSIONS

- Failure to follow the manufacturer's instructions for use.

NL

Sweeek garandeert dat alle onderdelen van het product vrij zijn van fabricage- en materiaalfouten gedurende een periode van 2 jaar vanaf de datum van ontvangst door de consument.

## LIJST VAN GARANTIE-UITSLUITINGEN

- Het niet volgen van de gebruiksaanwijzing van de fabrikant.

PT

Sweeek garante que todas as partes do produto estão livres de defeitos de fabrico e materiais durante um período de 2 anos a partir da data da sua recepção pelo consumidor.

## LISTA DE EXCLUSÕES DE GARANTIA

- Não seguir as instruções de utilização do fabricante.

IT

Sweeek garantisce che tutte le parti del prodotto sono prive di difetti di lavorazione e di materiali per un periodo di 2 anni dalla data di ricevimento da parte del consumatore.

## ELENCO DELLE ESCLUSIONI DALLA GARANZIA

- Mancata osservanza delle istruzioni d'uso del produttore.

DE

Sweeek garantiert für einen Zeitraum von zwei Jahren ab dem Datum des Erhalts durch den Verbraucher, dass alle Teile des Produkts frei von Verarbeitungs- und Materialfehlern sind.

## LISTE DER GARANTIEAUSSCHLÜSSE

- Die Nichtbeachtung der Gebrauchshinweise des Herstellers.

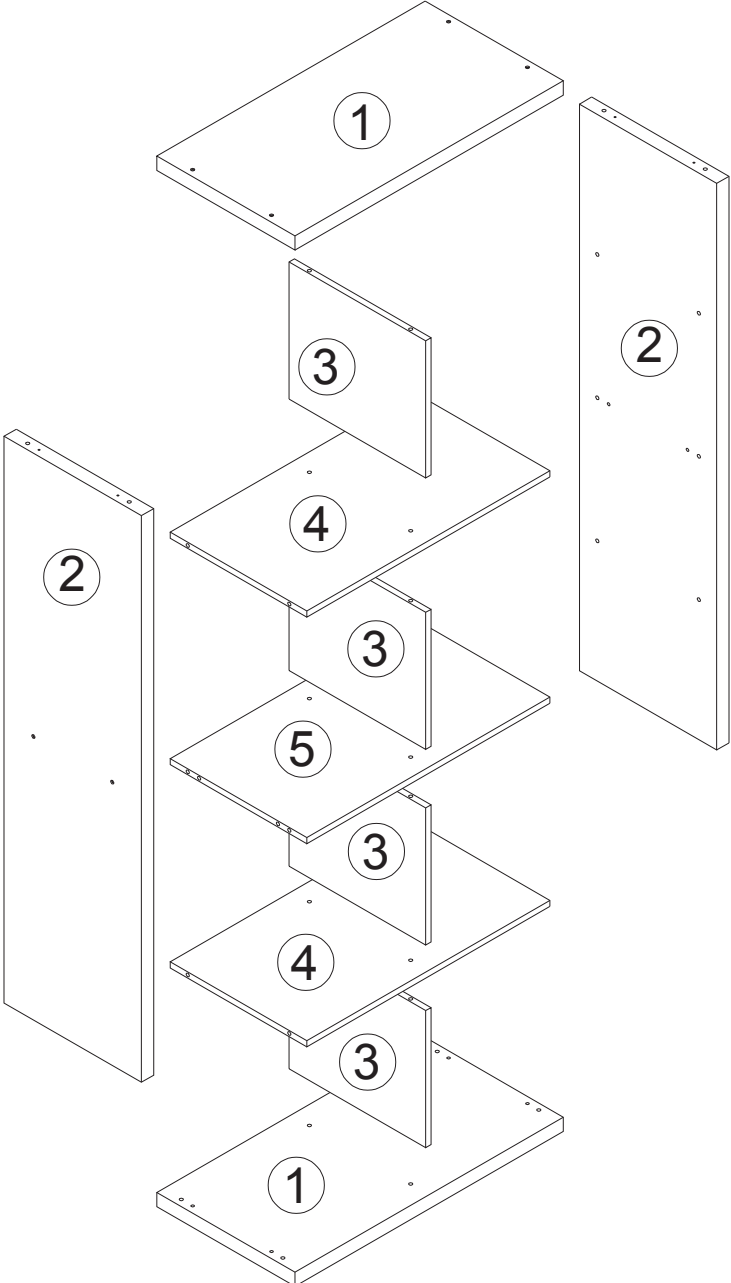

1  
× 2

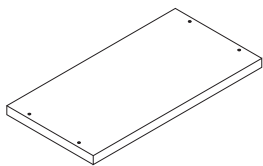

2  
× 2



3  
× 4

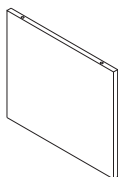

4  
× 2

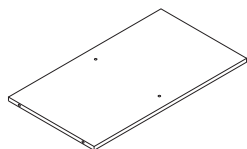

5  
× 1

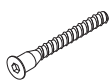
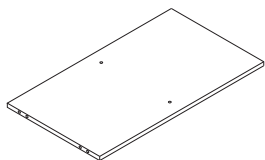

× 12  
M7x70mm



× 30  
M8x50mm



× 2  
M4x16mm



× 2



× 12

**1**  
B x2

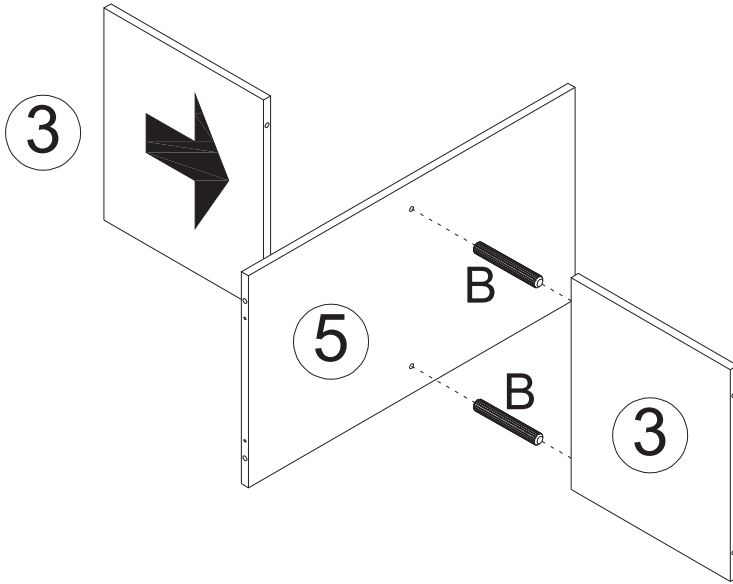

**2**  
B x4

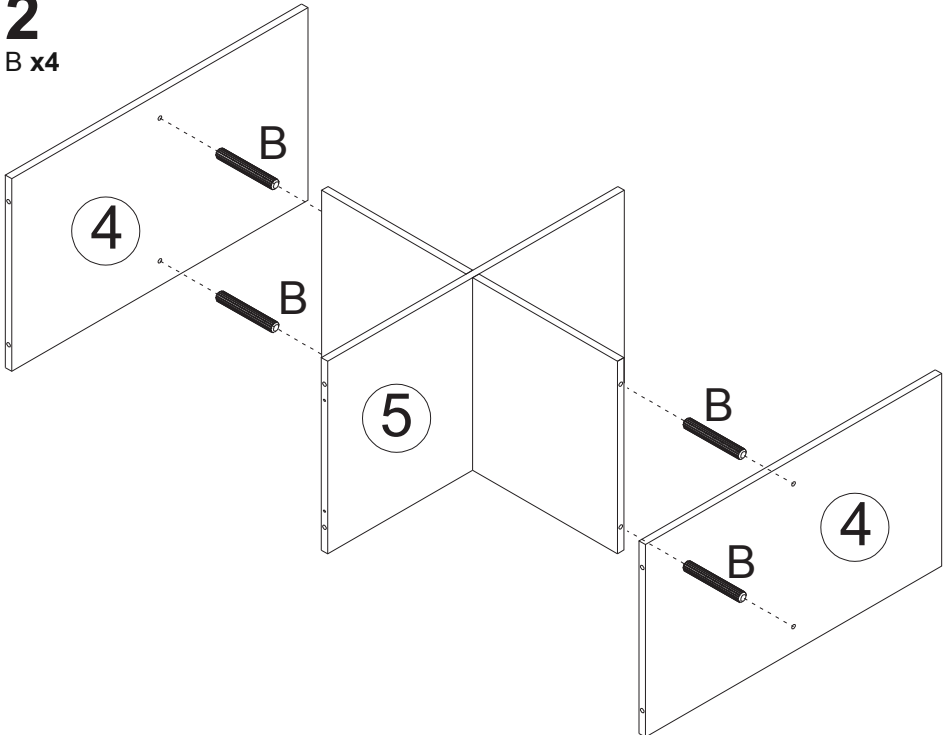

# 3

A x4  
B x12  
E x4

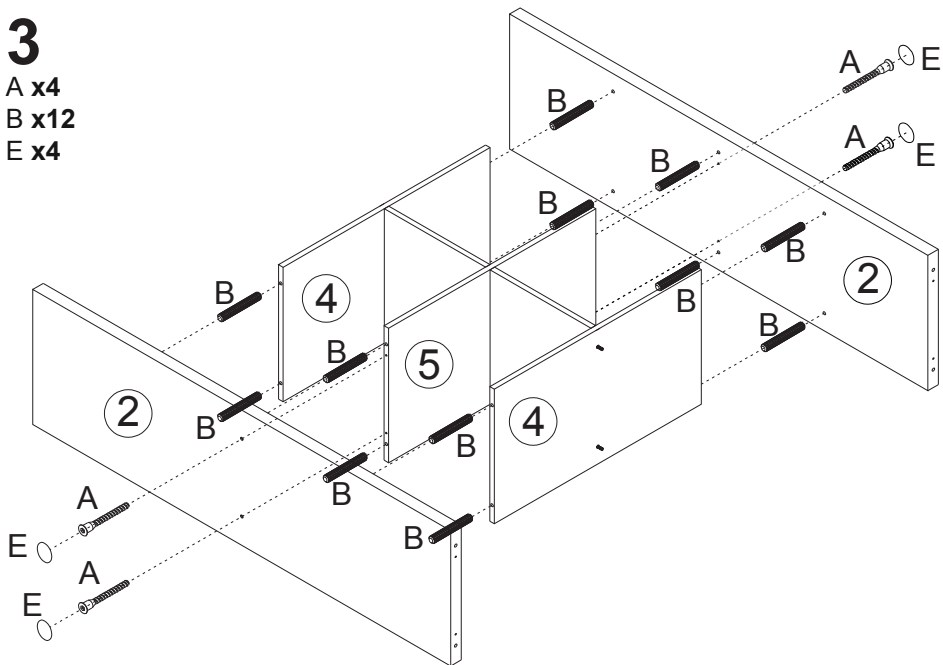

# 4

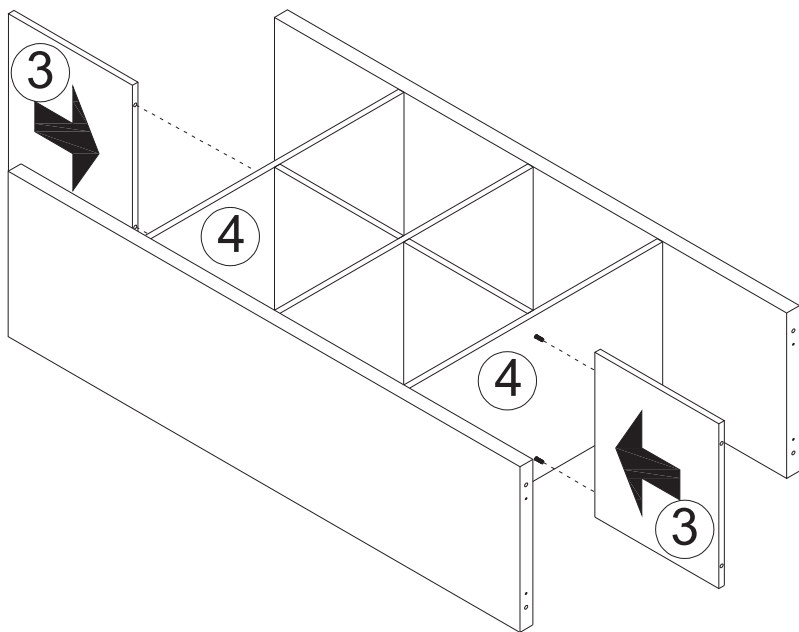

# 5

A x4  
B x6  
E x4

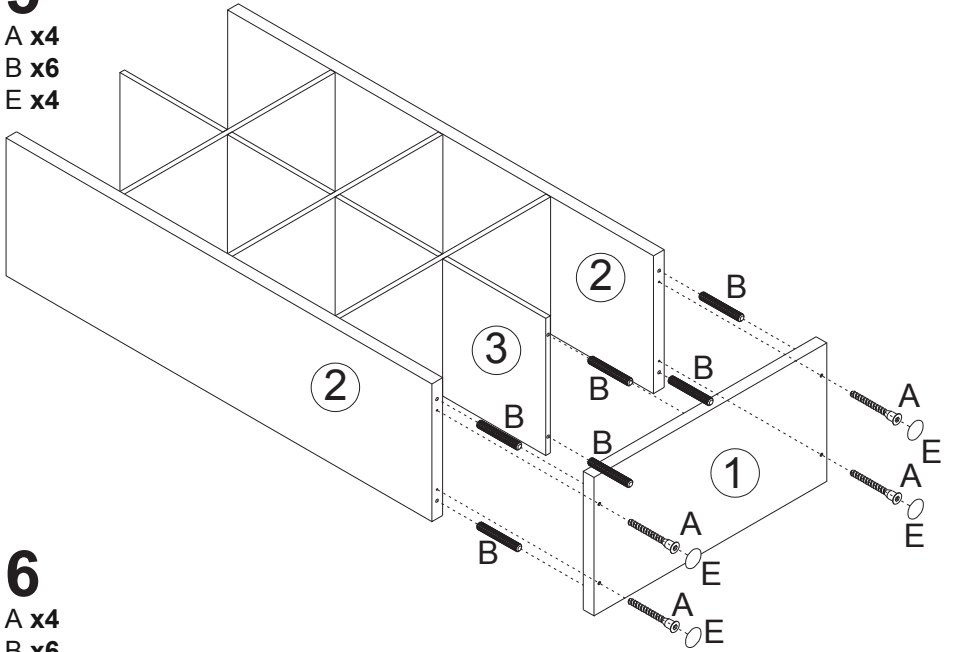

# 6

A x4  
B x6  
E x4

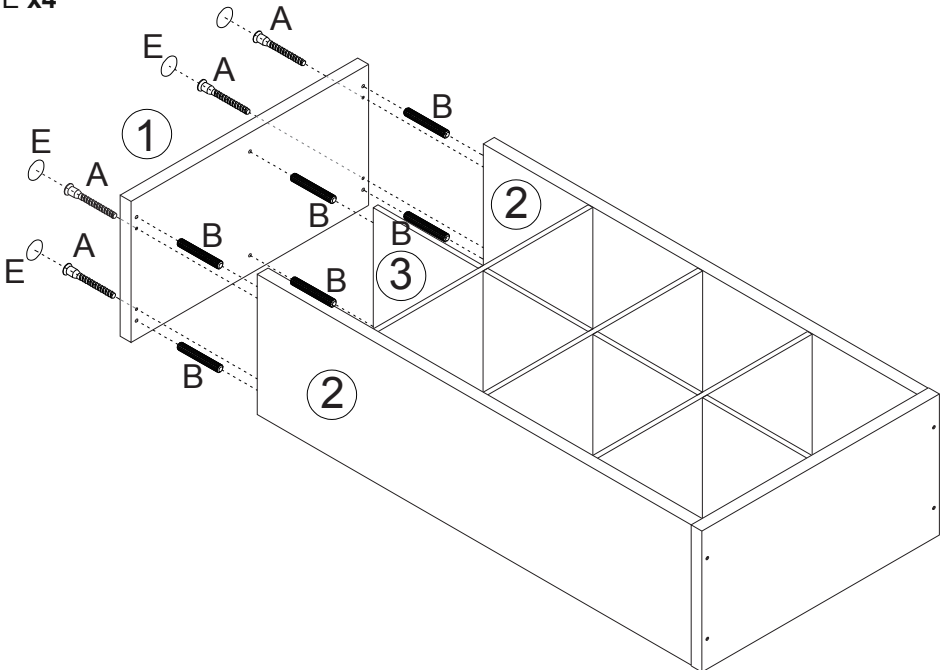

# 7

C x2

D x2

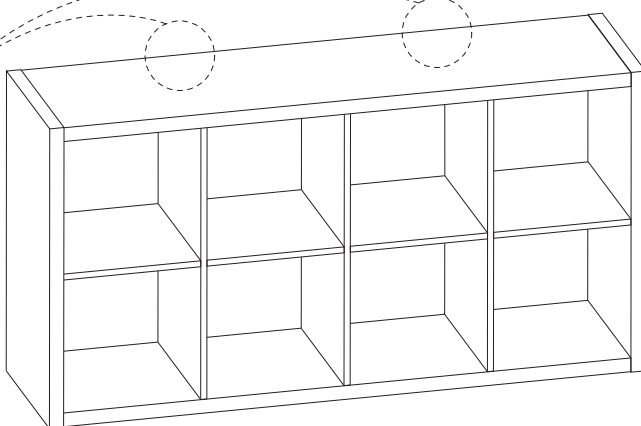
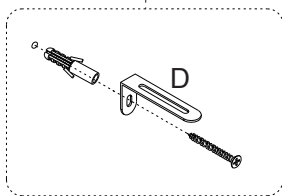
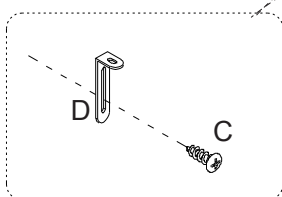
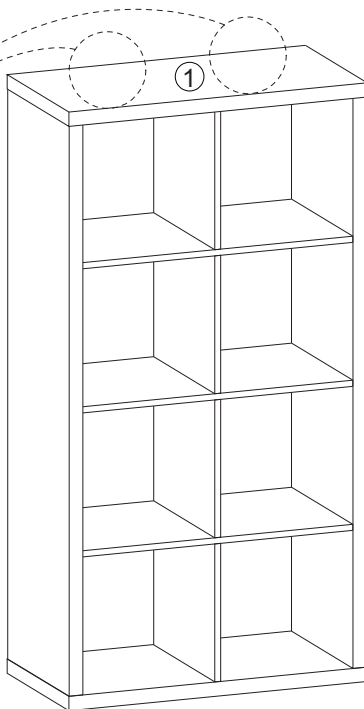
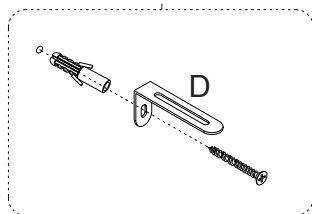
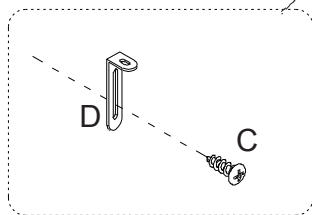
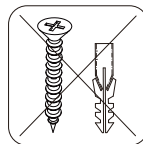

8

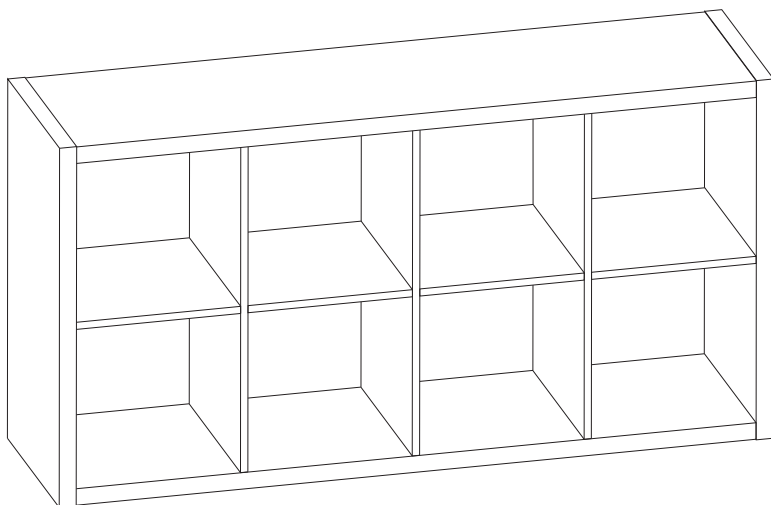
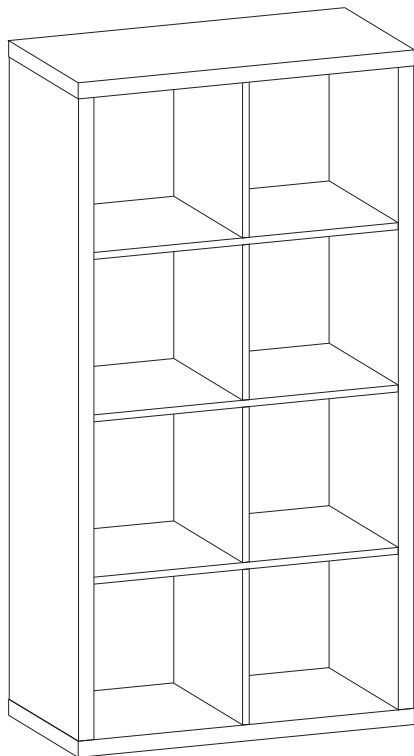









IMPORTÉ PAR WALIBUY SAS  
270 avenue de l'Espace, 59118 WAMBRECHIES - FRANCE

IMPORTADO POR WALIBUY SPAIN SL  
Avenida de Roma 157, 08011 BARCELONA - ESPAÑA

IMPORTED BY ALICE'S GARDEN UK LTD  
23 Copenhagen Street, LONDON N10JB - UNITED KINGDOM

INGEVOERD DOOR WALIBUY SAS  
270 avenue de l'Espace, 59118 WAMBRECHIES - FRANKRIJK

IMPORTADO POR WALIBUY SPAIN SL  
Avenida de Roma 157, 08011 BARCELONA - SPANHA

IMPORTATO DA WALIBUY ITALIA S.R.L  
Via Torino 60, 20123 MILANO - ITALIA

IMPORTIERT VON WALIBUY SAS  
270 avenue de l'Espace, 59118 WAMBRECHIES - FRANKREICH

IMPORTOWANE PRZEZ WALIBUY SAS  
270 avenue de l'Espace, 59118 WAMBRECHIES - FRANCJA

 SWEEEK ME



SERVICE APRÈS VENTE :

SERVICIO POSTVENTA :

AFTER SALES SERVICE :

AFTER-SALES :

SERVIÇO PÓS-VENDA :

CONTATTO :

CONTACT :

KUNDENDIENST :

SERWIS POGWARANCYJNY :

**[www.sweeek.help](http://www.sweeek.help)**



FR  
Donnez ou recyclez  
vos meubles.



Association

ou



Magasin

ou



Déchèterie

<https://quefairedemesdechets.fr>