

ISOPCBCLX2

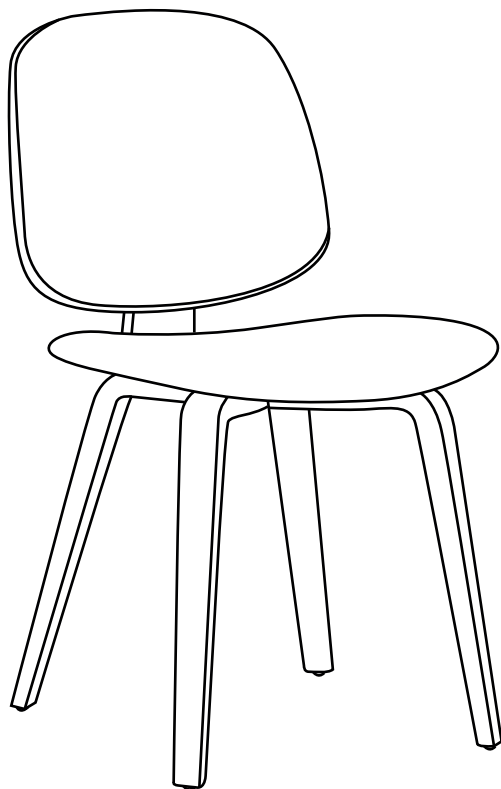

**FRANÇAIS**

Conseils d'entretien .....	6
Conseils d'utilisation .....	7
Garantie.....	8
Montage.....	9

**IMPORTANT, À CONSERVER  
POUR CONSULTATION ULTÉRIEURE :  
À LIRE ATTENTIVEMENT**

**ESPAÑOL**

Consejos de mantenimiento .....	6
Consejos de uso.....	7
Garantía.....	8
Montaje.....	9

**IMPORTANTE, CONSÉRVELO  
PARA FUTURAS REFERENCIAS:  
LEA ATENTAMENTE**

**ENGLISH**

Directions for maintenance.....	6
Directions for use.....	7
Warranty.....	8
Assembly.....	9

**IMPORTANT, RETAIN FOR FUTURE  
REFERENCE: PLEASE READ  
CAREFULLY**

## NEDERLANDS

Onderhoud.....	6
Gebruiksadviezen.....	7
Garantie.....	8
Montage.....	9

**BELANGRIJK, BEWAAR VOOR  
TOEKOMSTIGE REFERENTIE:  
ZORGVULDIG LEZEN**

## PORTUGUÊS

Dicas para cuidar.....	6
Dicas para usar .....	7
Garantia.....	8
Montagem.....	9

**IMPORTANTE, CONSERVE A  
REFERÊNCIA DA FATURA:  
LEIA CUIDADOSAMENTE**

## ITALIANO

Consigli per la manutenzione .....	6
Consigli d'uso .....	7
Garanzia.....	8
Montaggio.....	9

**IMPORTANTE, CONSERVARE PER  
ULTERIORI CONSULTAZIONI:  
LEGGERE ATTENTAMENTE**

## DEUTSCH

Pflegehinweise .....	6
Verwendungshinweise.....	7
Garantie.....	8
Montage .....	9

**WICHTIG, FÜR SPÄTEREN  
GEBRAUCH AUFBEWAHREN:  
BITTE SORGFÄLTIG LESEN**



Destiné à un usage domestique  
Destinado a un uso doméstico  
For domestic use  
Bestemd voor huishoudelijk gebruik  
Para uso doméstico  
Destinato ad un uso domestico  
Nur für den Privatgebrauch vorgesehen



**Attention** : risques de blessures  
**Cuidado** : riesgo de lesión  
**Warning** : risk of injuries  
**Waarschuwing**: risico op verwondigen  
**Cuidado**: risco de ferimentos  
**Attenzione** : rischio infortunio  
**Warnung**: Verletzungsgefahr



Garantie : 2 ans  
Garantía : 2 años  
Warranty: 2 years  
Garantie: 2 jaar  
Garantia: 2 anos  
Garanzia : 2 anni  
Garantie: 2 Jahre



Poids maximal : 110kg  
Peso máximo : 110kg  
Maximum weight : 110kg  
Maximale gewicht: 110kg  
Peso máximo: 110kg  
Peso massimo: 110kg  
Maximale Belastbarkeit: 110kg

# CONSEILS D'ENTRETIEN / CONSEJOS DE USO / DIRECTIONS FOR MAINTENANCE / ONDERHOUD / DICAS PARA CUIDAR / CONSIGLI PER LA MANUTENZIONE / PFLEGEHINWEISE

---

FR

Bois: Dépoussiérer régulièrement avec un chiffon propre, doux et sec. Proscrire tout abrasif et produits acides. Ne jamais employer de solvants. Nettoyage professionnel uniquement.

ES

Quitar el polvo regularmente con un paño limpio, suave y seco. No utilice productos abrasivos o ácidos. No utilice nunca disolventes de limpieza. Sólo se debe realizar una limpieza profesional.

EN

Regularly dust with a clean, soft and dry cloth. Do not use any abrasive or acidic products. Never use cleaning solvents. Professional cleaning only.

NL

Stof regelmatig af met een schone, zachte en droge doek. Alleen Sluit alle schurende en zure producten uit. Gebruik nooit oplosmiddelen. Alleen professionele reiniging.

PT

Pó regularmente com um espanador limpo, macio e seco. Proibir qualquer esfregão e produtos ácidos. Nunca utilizar solvente de limpeza. Apenas limpeza profissional.

IT

Spolverare regolarmente con un panno pulito, morbido e asciutto. Non usare prodotti abrasivi o acidi. Non usare mai solventi. Solo pulizia professionale.

DE

Regelmäßig mit einem sauberen, weichen und trockenen Tuch abstauben. Scheuernde und säurehaltige Mittel dürfen keinesfalls angewendet werden. Verwenden Sie niemals Lösungsmittel. Nur professionelle Reinigung.

## CONSEILS D'UTILISATION / CONSEJOS DE USO / DIRECTIONS FOR USE / GEBRUIKSAADVIEZEN / DICAS PARA USAR / CONSIGLI D'USO / VERWENDUNGSHINWEISE

---

FR

Ne pas monter sur la chaise / Ne pas se balancer. En effet, cela peut entraîner une dégradation du produit, voire des blessures, n'entrant pas dans le cadre de la garantie.

ES

No se ponga de pie sobre la silla ni se columpie en ella. Esto puede provocar daños en el producto o incluso lesiones, que no están cubiertas por la garantía.

EN

Do not stand up on the chair and/or swing on the chair. Doing so may cause damage to the product or even injury, which is not covered by the warranty.

NL

Ga niet op de stoel staan/Niet schommelen. Dit kan leiden tot schade aan het product of zelfs letsel, wat niet onder de garantie valt.

PT

Não se levantar sobre a cadeira e/ou balançar sobre a cadeira. Isto pode levar a danos no produto ou mesmo a ferimentos, que não estão cobertos pela garantia.

IT

Non salire sulla sedia / Non dondolare. Ciò può causare danni al prodotto o addirittura lesioni, che non sono coperte dalla garanzia.

DE

Nicht auf den Stuhl stellen / Nicht schaukeln. Dies kann nämlich zu einer Beschädigung des Produkts oder sogar zu Verletzungen führen, die nicht unter die Garantie fallen.

# GARANTIE / GARANTÍA / WARRANTY / GARANTIA / GARANZIA

---

FR

Sweeek garantit toutes les pièces du produit contre tout vice de fabrication et de matériau pendant une période de 2 ans à compter de la date de réception par le consommateur.

## LISTE DES EXCLUSIONS DE GARANTIE

- Le non-respect des conseils d'utilisation du constructeur.

ES

Sweeek garantiza que todas las piezas del producto están libres de defectos de fabricación y materiales durante un periodo de 2 años a partir de la fecha de recepción por parte del consumidor.

## LISTA DE EXCLUSIONES DE LA GARANTÍA

- No seguir las instrucciones de uso del fabricante.

EN

Sweeek warrants all parts of the product to be free from defects in workmanship and materials for a period of 2 years from the date of receipt by the consumer.

## LIST OF WARRANTY EXCLUSIONS

- Failure to follow the manufacturer's instructions for use.

NL

Sweeek garandeert dat alle onderdelen van het product vrij zijn van fabricage- en materiaalfouten gedurende een periode van 2 jaar vanaf de datum van ontvangst door de consument.

## LIJST VAN GARANTIE-UITSLUITINGEN

- Het niet volgen van de gebruiksaanwijzing van de fabrikant.

PT

Sweeek garante que todas as partes do produto estão livres de defeitos de fabrico e materiais durante um período de 2 anos a partir da data da sua recepção pelo consumidor.

## LISTA DE EXCLUSÕES DE GARANTIA

- Não seguir as instruções de utilização do fabricante.

IT

Sweeek garantisce che tutte le parti del prodotto sono prive di difetti di lavorazione e di materiali per un periodo di 2 anni dalla data di ricevimento da parte del consumatore.

## ELENCO DELLE ESCLUSIONI DALLA GARANZIA

- Mancata osservanza delle istruzioni d'uso del produttore.

DE

Sweeek garantiert für einen Zeitraum von zwei Jahren ab dem Datum des Erhalts durch den Verbraucher, dass alle Teile des Produkts frei von Verarbeitungs- und Materialfehlern sind.

## LISTE DER GARANTIEAUSSCHLÜSSE

- Die Nichtbeachtung der Gebrauchshinweise des Herstellers.



# MONTAGE / MONTAJE / ASSEMBLY / MONTAGEM / MONTAGGIO

1  
× 1

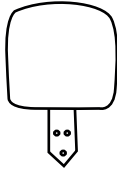

3  
× 1

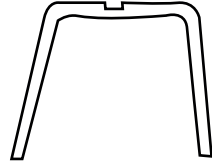

2  
× 1



4  
× 1

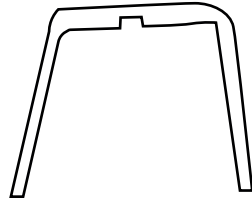

M6x32mm  
× 1

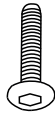

M6x40mm  
× 2

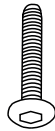

M6x45mm  
× 4

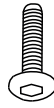

M6x35mm  
× 1



× 8



× 8



× 1

# 1

- B x1
- D x1
- E x2
- F x3
- G x1

# X2

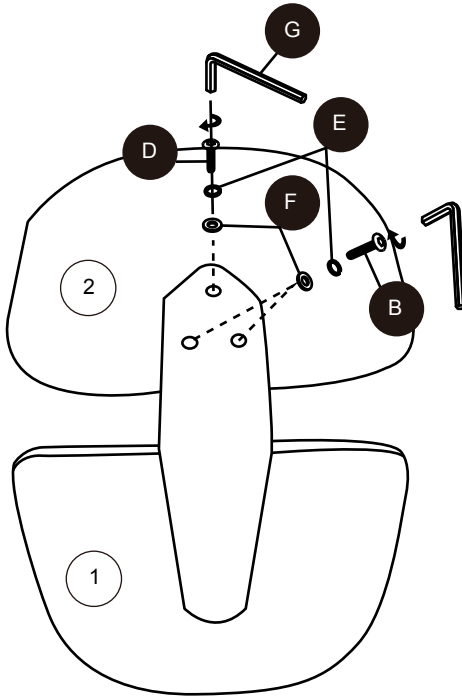

# 2

- A x1
- E x1
- F x1
- G x1

# X2

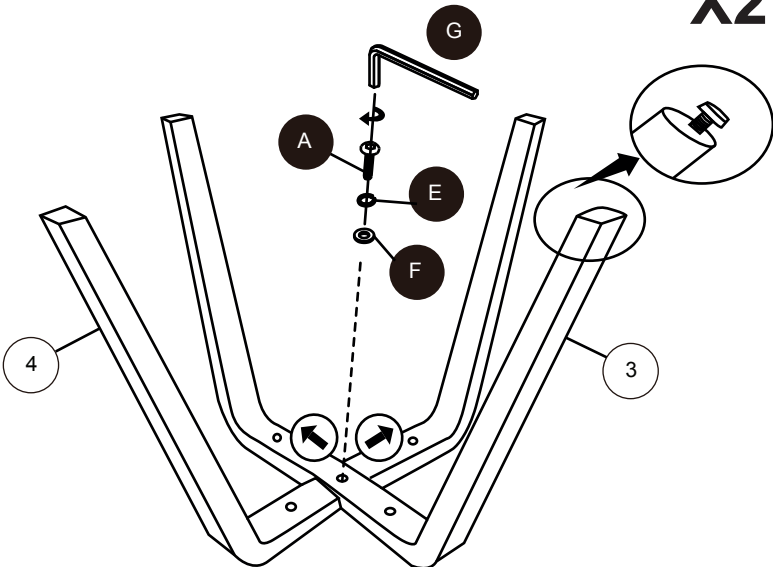

# 3

C x4  
E x4  
F x4  
G x1

# X2

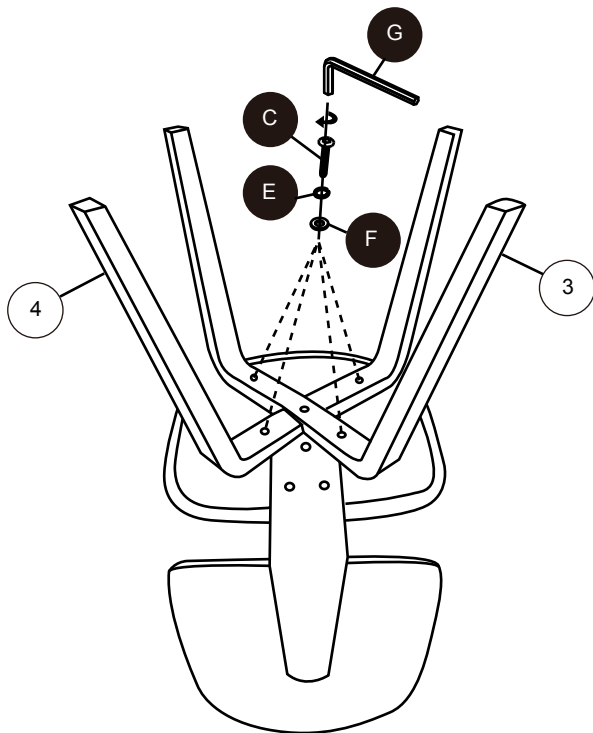

# 4

# X2

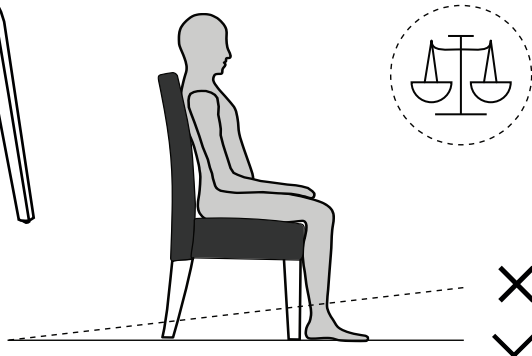

**5**

**X2**









IMPORTÉ PAR WALIBUY SAS  
270 avenue de l'Espace, 59118 WAMBRECHIES - FRANCE

IMPORTADO POR WALIBUY SPAIN SL  
Avenida de Roma 157, 08011 BARCELONA - ESPAÑA

IMPORTED BY ALICE'S GARDEN UK LTD  
23 Copenhagen Street, LONDON N10JB - UNITED KINGDOM

INGEVOERD DOOR WALIBUY SAS  
270 avenue de l'Espace, 59118 WAMBRECHIES - FRANKRIJK

IMPORTADO POR WALIBUY SPAIN SL  
Avenida de Roma 157, 08011 BARCELONA - SPANHA

IMPORTATO DA WALIBUY ITALIA S.R.L  
Via Torino 60, 20123 MILANO - ITALIA

IMPORTIERT VON WALIBUY SAS  
270 avenue de l'Espace, 59118 WAMBRECHIES - FRANKREICH

IMPORTOWANE PRZEZ WALIBUY SAS  
270 avenue de l'Espace, 59118 WAMBRECHIES - FRANCJA

 SWEEEK ME



SERVICE APRÈS VENTE :

SERVICIO POSTVENTA :

AFTER SALES SERVICE :

AFTER-SALES :

SERVIÇO PÓS-VENDA :

CONTATTO :

CONTACT :

KUNDENDIENST :

SERWIS POGWARANCYJNY :

**[www.sweeek.help](http://www.sweeek.help)**



FR  
Donnez ou recyclez  
vos meubles.



Association

ou



Magasin

ou



Déchèterie

<https://quefairedemesdechets.fr>